

DOCTORAL DISSERTATION

Application of Vehicle to Vehicle Communications  
in Encounters with Priority Vehicles

by

Hideaki NANBA

March 2020

Under supervision of

Professor Koji OGURI

Graduate School of Information Science and Technology

Aichi Prefectural University



## **ABSTRACT OF THE DOCTORAL DISSERTATION**

The technology of vehicle to vehicle communication is considered to be an effective technology for providing driving assistance to the elderly and reducing traffic accidents. In addition, vehicle to vehicle communication is expected to develop into automated driving systems.

The purpose of this dissertation is to verify the effectiveness of vehicle to vehicle communication by investigating its superiority and its application to new fields from the perspective of how to expand its use. That is why the progression of vehicle to vehicle communication to safety supports and automated vehicles. This dissertation addresses of four themes.

Theme 1 is verification of the superiority of vehicle to vehicle communication in comparison with other means of recognition by through analysis of actual data and the derived deceleration stop model. Theme 2 is evaluation of the desired perceived distance and performance of vehicle to vehicle communication when approaching a tramcar as a new application to increase efficiency of road space utilization. Theme 3 is to suggest the possibility of reducing rapid deceleration through advanced operation and earlier recognition by using vehicle to vehicle communication. Theme 4 is a proposal for a method of determining the timing when pre-deceleration should be commenced using the deceleration stop model derived from this research.

By examining these four themes, this dissertation provides basic data utilizing the effectiveness of vehicle to vehicle communication when developing driving formats for automated driving vehicles.

## Table of Contents

<b>Index of Abbreviations</b> .....	vii
<b>Index of Tables</b> .....	viii
<b>Index of Figures</b> .....	x
<b>Chapter One: Introduction</b> .....	1
<b>1.1 Background of Study</b> .....	1
1.1.1 The Background and Current State of Vehicle to Vehicle Communication ..1	
1.1.2 Recognition of Priority Vehicles and Driving Styles Required by Nearby Vehicles for Coexistence .....	3
1.1.3 Expectations for Vehicle to Vehicle Communication in Automated Driving Vehicles .....	4
<b>1.2 Purpose of This Study</b> .....	5
1.2.1 Research to Solve Current Issues .....	5
1.2.2 Contribution of This Research Result to the Transportation Society .....	6
<b>1.3 Structure of This Dissertation</b> .....	6
<b>Chapter Two: Superiority of Vehicle to Vehicle Communications</b> .....	9
<b>2.1 Background</b> .....	9
<b>2.2 Deceleration of Manual Driving Car at an Intersection</b> .....	10
<b>2.3 Deceleration Model of Giving Way to an Emergency Vehicle</b> ....	13
2.3.1 Requirements .....	13

2.3.2 Application of IDM (Intelligent Driver Model).....	14
2.3.3 Modification of the IDM and Parameter Adjustment .....	17
2.3.4 Derivation of Parameter $b$ and $\gamma$ .....	19
2.3.5 Comparison of the Deceleration Model and Actual Data .....	26
<b>2.4 Consideration of the Distance Required to Stop</b>	
<b>with the Desired Deceleration Behavior .....</b>	<b>28</b>
<b>2.5 Confirmation of Recognition Distance for Each Recognition</b>	
<b>Method .....</b>	<b>30</b>
2.5.1 Confirmation of Recognition Distance .....	30
2.5.2 Confirmation Result .....	32
<b>2.6 Consideration of the Recognition Distance and Recognition</b>	
<b>Method Required for Giving Way by an Automated Driving Car</b>	
.....	33
<b>2.7 Summary .....</b>	<b>36</b>
<b>Chapter Three: Vehicle to Vehicle Communication with Trams .....</b>	<b>39</b>
<b>3.1 Background .....</b>	<b>39</b>
<b>3.2 Requested Specification for Possible Use Cases .....</b>	<b>42</b>
<b>3.3 Outline of the Hiroshima Field Operational Test .....</b>	<b>45</b>
<b>3.4 Tramcar Stop Motion .....</b>	<b>48</b>

<b>3.5 Performance of V2V Radio Communication System</b>	51
<b>3.6 Measurements while Traveling</b>	53
<b>3.7 Measurements in Fixed Location</b>	56
<b>3.8 Summary</b>	58

**Chapter Four: Considerations of Advance Deceleration Using Vehicle**

<b>to Vehicle Communications</b>	61
<b>4.1 Background</b>	61
<b>4.2 Superiority of Vehicle to Vehicle Communication in Emergency Vehicle Recognition</b>	61
<b>4.3 Experiments by Driving Simulator</b>	63
4.3.1 Driving simulator system	63
4.3.2 Subjects	65
4.3.3 Experimental process	66
4.3.4 Driving Scenario from backward approach	67
4.3.5 Driving Scenario from lateral direction approach	68
<b>4.4 Experimental Data Using Non-V2V Recognition</b>	69
4.4.1 The case of the siren sound recognition from backward approach	69
4.4.2 The case of the red light recognition from backward approach	72

4.4.3 The case of the siren sound recognition from lateral direction approach .....	73
<b>4.5 Safety and Ride Comforts .....</b>	<b>74</b>
<b>4.6 Experimental Data Using V2V Recognition .....</b>	<b>78</b>
4.6.1 The case of V2V recognition from backward approach with pre-deceleration .....	78
4.6.2 The case of V2V recognition from lateral direction approach with short pre-deceleration .....	80
<b>4.7 Adaptation to Automated Driving Vehicles .....</b>	<b>83</b>
<b>4.8 Summary and Future Work .....</b>	<b>84</b>

## **Chapter Five: Application of Deceleration Stop Model**

<b>to Pre-Deceleration .....</b>	<b>87</b>
<b>5.1 Background .....</b>	<b>87</b>
<b>5.2 Derivation of Deceleration Stop Model .....</b>	<b>88</b>
5.2.1 Consideration of mathematical model .....	88
5.2.2 Deceleration Model of Skilled Drivers .....	88

5.2.3	Use of IDM (Intelligent Driver Model)	91
5.2.4	Comparison between the derived deceleration stop model and actual data	93
<b>5.3</b>	<b>Stop Distance Obtained from Deceleration Stop Model</b>	<b>95</b>
<b>5.4</b>	<b>Determining the Start Timing of Deceleration Stop Action</b>	<b>97</b>
<b>5.5</b>	<b>Summary</b>	<b>98</b>
<b>Chapter Six:</b>	<b>Conclusion</b>	<b>101</b>
<b>Acknowledgements</b>		<b>109</b>
<b>List of Publications</b>		<b>110</b>



## **Index of Abbreviations**

ARIB	Association of Radio Industries and Businesses
Ds	Distance
DS	Driving Simulator
FOT	Field Of Test
IDM	Intelligent Driver Model
ITS	Intelligent Transport System
LOS	Line Of Sight
LRT	Light Rail Transit
MLIT	Ministry of Land Infrastructure, Transport and Tourism
NLOS	Non Line Of Sight
PAR	Packet Arrival Rate
STD	Standard
UTMS	Universal Traffic Management Systems
V2V	Vehicle to Vehicle Communication

## Index of Tables

Table 2-1 Parameters of IDM .....	15
Table 2-2 Stoppable distance vs. Appropriate maximum deceleration .....	20
Table 2-3 Initial velocity $v_j$ vs. Exponential variable $\gamma$ .....	25
Table 2-4 The distance to the ambulance at the recognition time at Location 1 .....	32
Table 2-5 The distance to the ambulance at the recognition time at Location 2 .....	32
Table 2-6 Parameters for required recognition distance .....	34
Table 2-7 Results of required recognition distance .....	34
Table 3-1 Specification of the positional relationship .....	44
Table 3-2 Actual measurement results .....	44
Table 3-3 Wireless system (ARIB STD T-109) .....	51
Table 4-1 The recognized distance in the real situation .....	62
Table 4-2 The data of five subjects notifying an ambulance from backward by siren sound .....	70

Table 4-3 The average data of the subjects notifying an ambulance by siren sound and red light.....75

Table 4-4 The data of the subjects notifying an ambulance by V2V .....81

Table 5-1 Parameters and Set Values .....92

## Index of Figures

Figure 1-1 Scene of a public road with traffic congestion.....	2
Figure 1-2 Ambulance traveling time.....	2
Figure 2-1 Overview of the Motoyama intersection and example of an ambulance route .....	10
Figure 2-2 A scene of an ambulance entering the intersection .....	11
Figure 2-3 Examples of vehicle movement data .....	12
Figure 2-4 Rough stop examples .....	13
Figure 2-5 Smooth stop examples .....	13
Figure 2-6 Velocity characteristic with IDM .....	16
Figure 2-7 Deceleration characteristic with IDM .....	16
Figure 2-8 Procedure of the derivation of $b$ and $\gamma$ .....	19
Figure 2-9 Velocity for each $S_j$ at 60 km/h .....	21

Figure 2-10 Deceleration for each $S_j$ at 60 km/h .....	21
Figure 2-11 $S_j$ vs. $b$ for each initial velocity .....	22
Figure 2-12 Approximate curve at $v_j = 60$ km/h .....	23
Figure 2-13 Approximate curve at $v_j = 50$ km/h .....	23
Figure 2-14 Approximate curve at $v_j = 40$ km/h .....	24
Figure 2-15 Approximate curve at $v_j = 30$ km/h .....	24
Figure 2-16 Approximation formula of exponential part.....	25
Figure 2-17 Comparison of velocity characteristics between the model and the actual data No.15 ( $v_j = 18.3\text{m/s}$ , $s_j = 53.1\text{m}$ ) .....	26
Figure 2-18 Comparison of deceleration characteristics between the model and the real data No.15 ( $v_j = 18.3\text{m/s}$ , $s_j = 53.1\text{m}$ ) .....	26
Figure 2-19 Comparison of velocity characteristics between the model and the actual data No.8 ( $v_j = 12.2\text{m/s}$ , $s_j = 57.5\text{m}$ ) .....	27
Figure 2-20 Comparison of deceleration characteristics between the model and the actual data, No.8 ( $v_j = 12.2\text{m/s}$ , $s_j = 57.5\text{m}$ ) .....	27

Figure 2-21 Velocity characteristics under the conditions of a smooth stop and rough stop ( $v_j = 40\text{km/h}$ ).....	29
Figure 2-22 Deceleration characteristics under the conditions of a smooth stop and rough stop ( $v_j = 40\text{km/h}$ ) .....	29
Figure 2-23 Stop distance under the conditions of a smooth stop and rough stop .....	30
Figure 2-24 Location 1 (N35.1863, E136.9047) .....	30
Figure 2-25 Location 2 (N35.1465, E136.9648) .....	31
Figure 2-26 The positioning between the ambulance and the automated driving car (opposite positions) .....	33
Figure 2-27 The positioning between the ambulance and the automated driving car (crossing positions) .....	33
Figure 3-1 A car crossing the track of a tramcar .....	40
Figure 3-2 An automated driving car crossing the tramcar track, its backward invisible ...	42
Figure 3-3 Probable collision accident of tramcar and automated driving car .....	43
Figure 3-4 Positional relationship in backward invisible .....	43

Figure 3-5 Experimental measurement system .....	46
Figure 3-6 Pictures of the equipment .....	46
Figure 3.7 Traveling route of tramcar and communication quality confirmation places ....	47
Figure 3-8 Velocity and acceleration from point ㉠ to ㉢ .....	48
Figure 3-9 Data obtained at Hiroshima City Hall Station .....	49
Figure 3-10 Data obtained at Station Chuden .....	49
Figure 3-11 Antenna height in communication between car and car .....	51
Figure 3-12 Packet arrival rate in communication between car and car .....	52
Figure 3-13 Antenna height during communication between tramcar and car .....	53
Figure 3-14 ㉠ Around Hiroshima City Hall Station .....	54
Figure 3-15 ㉡ Around Broadcast Station (NHK) .....	54
Figure 3-16 ㉢ Around Intersection KAMIYA .....	55
Figure 3-17 Accumulated PAR at 0, 25, 75 vehicles .....	57
Figure 4-1 Appearance of the driving simulator .....	64
Figure 4-2 Driving simulator system configuration .....	64
Figure 4-3 Forward screen and car-navigation display .....	65

Figure 4-4 Scenario configuration of a subject .....	67
Figure 4-5 Driving scenario of an ambulance from backward approach .....	68
Figure 4-6 Driving scenario of an ambulance from lateral direction approach .....	69
Figure 4-7 Velocity & Brake, Deceleration and Jerk in Notice by siren sound from backward .....	71
Figure 4-8 Velocity & Brake, Deceleration and Jerk in Notice by red light from backward .....	72
Figure 4-9 Velocity & Brake, Deceleration and Jerk in Notice by siren sound from lateral direction .....	74
Figure 4-10 Velocity & Brake, Deceleration and Jerk in Notice by V2V from backward .....	79
Figure 4-11 Velocity & Brake, Deceleration and Jerk in Notice by V2V from lateral direction .....	81
Figure 5-1 Deceleration vs. Separation distance .....	90
Figure 5-2 Deceleration vs. Elapsed time .....	91
Figure 5-3 Comparison of DS experimental data and simulation result .....	93
Figure 5-4 Deceleration simulation using deceleration stop model .....	94
Figure 5-5 Deceleration and stop distance for initial velocity (Maximum deceleration is $-2.94 \text{ m/s}^2$ for every velocity) .....	95



Figure 5-6 Relationship between initial velocity and distance to stop point .....96

Figure 5-7 Decision-making flow chart of deceleration start timing .....97

# Chapter One: Introduction

## 1.1 Background of Study

### 1.1.1 The Background and Current State of Vehicle to Vehicle Communication

It was in the early 2000s that research and development began in various parts of the world for the practical application of vehicle-vehicle communication. In Japan, emphasis was placed on shared road to vehicle communication and vehicle to vehicle communication, and research on communication protocols to achieve this is actively conducted [1-1]. As experiments were repeatedly conducted, the frequency used in the 5.8 GHz band and transmission power were proven to be effective only at short distances, and the desire to assign a new frequency for next-generation ITS increased. Later, use of the UHF band began to be considered thanks to the efficiency gains associated with the transition from analog to digital terrestrial television [1-2], [1-3].

Fortunately, it was announced in December 2007 that the 760 MHz band would be allocated for road-to-vehicle and vehicle-vehicle communications. After that, it became possible to use the 760 MHz band for shared roadside to roadside communication. Services using vehicle to vehicle communication and road to vehicle communication became operations in 2015 under the service name ITS Connect. Four years have passed since service began, and there are over 100,000 vehicles equipped with wireless devices. However, in order to support safety, it is ideal for all vehicles to be equipped with wireless devices, and it has become a major issue to promote the popularization by emphasizing how useful vehicle to vehicle and road to vehicle communication is.

In order to convey the effectiveness, it is necessary to expand the fields of application and services. One example is vehicle to vehicle communication among tramcars, general vehicles and buses to enable sharing of tramways with general vehicles or buses.

Figure 1-1 shows the traffic congestion in Hiroshima City.



Fig. 1-1 Scene of a public road with traffic congestion

Another use is the application of vehicle to vehicle communication between priority vehicles such as emergency vehicles and general vehicles.

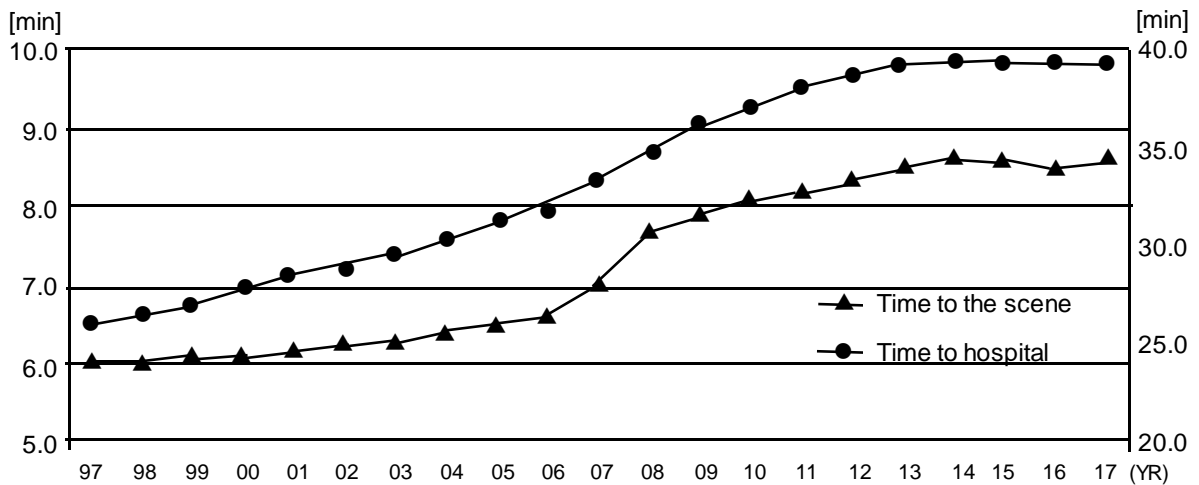

Fig. 1-2 Ambulance traveling time

Figure 1-2 illustrates the changes in the time required for an ambulance to reach the scene and to take the sick and injured to a hospital [1-4]. The times are increasing year by year.

For vehicle to vehicle communication between a tramcar and a general vehicle, it is necessary to evaluate the communication performance in an actual environment. The evaluations of communicable performance of vehicle to vehicle communication among cars have been sufficiently performed in practical fields. On the other hand, in the case of a tram, the communication performance has not been investigated from the viewpoint of co-running with the tram. Evaluations have been of function and serviceability from the general vehicle side, not communication performance.

Another topic concerns the recognition of priority vehicles, especially emergency vehicles. It is an important issue to notify nearby vehicles early in their approach. In the future, automated driving vehicles and priority vehicles will have to co-exist on public roads.

#### 1.1.2 Recognition of Priority Vehicles and Driving Styles Required by Nearby Vehicles for Coexistence

Currently, the following are stipulated in Article 39 and Article 40 of the Road Traffic Law regarding the travel of emergency vehicles.

“Emergency vehicles shall have priority during emergency driving, and tramcars and general vehicles must stop, not enter intersections, and not interfere with the driving of emergency vehicles.” This is a strict law with criminal provisions.

An emergency vehicle is a vehicle having a means for notifying nearby vehicles and persons of an emergency vehicle such as a fire truck or an ambulance during an emergency

run. In this study, vehicles (for example, trams) traveling on priority routes (exclusive routes and priority lanes) are treated as priority vehicles in addition to the above-mentioned emergency vehicles.

In this paper, it is assumed that an automated driving vehicle adopts the same driving style as a manually driven vehicle when the automated driving vehicle travels on a general road even in the age of automated driving vehicles. That is, even when automated driving vehicles become widespread, automated driving vehicles will give way to priority vehicles and support the traveling of priority vehicles. In order to coexist with priority vehicles, automated driving vehicles will be required to have a driving style that recognizes the priority vehicle at an early stage and behave in a predetermined manner.

### 1.1.3 Expectations for Vehicle to Vehicle Communication in Automated Driving Vehicles

Automated driving systems are expected to be realized as an effective means of increasing the number of senior drivers and reducing traffic accidents. Currently, automatic driving on highways and automatic parking at specific sites are being developed as highly feasible projects [1-5]. On the other hand, automated driving systems on general roads are technically difficult, and it is said that it will take some time for practical application. The automated driving systems currently considered mainstream are an application of advanced IT (Information Technology) and are being vigorously developed around the world together with sensors.

However, it is feared that price will become a bottleneck for automated vehicles to become widespread. If the automated driving systems currently considered mainstream are called sensor-rich systems, the required systems are referred to as sensor-lean systems. In a sensor-lean system, it is essential to broaden the area that can be recognized by

exchanging information with nearby cars and road management systems, rather than acquiring information only with the mounted sensors. In order to exchange information with other vehicles, vehicle to vehicle communication is indispensable and its spread is urgent.

## **1.2 Purpose of This Study**

### 1.2.1 Research to Solve Current Issues

Vehicle to vehicle communication is a technology that is expected to be used not only for initial safe driving support but also for automated driving. The current challenge is how to emphasize the effectiveness and promote dissemination. The most advantageous characteristic of vehicle to vehicle communication is that the environment can be recognized in a wider area than other sensors thanks to its large communication distance. The issue regarding the recognition of priority vehicles is how quickly they can be recognized. In particular, in the case of automated driving operation, it is desired that the margin time be longer than that of manual operation. This study is to verify the proposal that the above two problems can be solved by using vehicle to vehicle communication. If there is a problem, author would like to propose a means to solve it. In summary, the purpose of this study is as follows:

Looking ahead to the age of automated driving, vehicle to vehicle communication will support safety and avoid passenger discomfort during encounters with priority vehicles. The purpose of this study to verify the effectiveness of vehicle to vehicle communication and to propose effective uses.

### 1.2.2 Contribution of This Research Result to the Transportation Society

A unified driving style for nearby vehicles is required to achieve effective travel by priority vehicles at intersections and conduct deceleration and stopping without stress to passengers. A unified driving style for automated driving vehicles may lead to a safer and more comfortable transportation society. It is our hope that the social acceptability of automated driving vehicles can be promoted by using the results of this research.

## 1.3 Structure of This Dissertation

In this dissertation, verification of the effectiveness of vehicle to vehicle communication and proposal of effective uses are described by looking to the future of automated driving systems. In practice, vehicle to vehicle communication would support safety and avoid passenger discomfort during encounters with priority vehicles. This paper comprises chapters with the following four themes.

Theme 1: To verify the superiority of vehicle to vehicle communication by comparison with other recognition means, by using real data analysis and a derived deceleration stop model.

Theme 2: To evaluate the desired perceived distance and performance of vehicle to vehicle communication when approaching a tramcar as a new application to increase the efficiency of road space utilization.

Theme 3: To suggest the potential for reducing rapid deceleration through advanced operation and earlier recognition by using vehicle to vehicle communication.

Theme 4: To propose a method for determining the timing to commence pre-deceleration using the deceleration stop model derived from this research.

The chapter structures are as follows:

Chapter Two relates to Theme 1 by analyzing the actual behavior data of the nearby vehicles during encounters with priority vehicles; the superiority of the vehicle to vehicle communication for recognition is described.

In Chapter Three, which relates to Theme 2, the experimental results of vehicle to vehicle communication with a tramcar is shown. It shows that there is no excess or deficiency in the vehicle to vehicle communication system with respect to mutual distance and communication capacity, which are necessary for an automated driving vehicle to recognize the approach of the tramcar.

Chapter Four, which relates to Theme 3, shows the possibility of avoiding excessive deceleration and unpleasant over-deceleration (jerking) by nearby vehicles when encountering emergency vehicles through pre-decelerating using vehicle to vehicle communication.

Chapter Five, which relates to Theme 4, proposes a method to apply the deceleration stop model described in Chapter 2 to pre-deceleration driving when encountering an emergency vehicle.

Chapter Six is the conclusion and description of future work.



## References

- [1-1] M. Aoki and H. Fujii, "Inter-vehicle communication: technical issues on vehicle control application," IEEE Communication Mag., vol. 34, no 10, pp.90 -93, Oct. 1996
- [1-2] Shengwei Cai, "Initial Investigation of Dual-Frequency-Channel Roadside-to Vehicle Safety Communication System", ITS World Congress, 1<sup>st</sup> in TO094, 2007
- [1-3] Katsuyoshi Sato, Kyoichi Iigusa, Hiroshi Harada, "Propagation characteristics for inter-vehicle communication in the 720 MHz band", IEICE, The 10<sup>th</sup> International Conference on Intelligent Transport Systems Telecommunications (ITST 2010), 2010
- [1-4] Fire and Disaster Management Agency (FDMA), "Overview of the 2018 White Paper on Fire Service"
- [1-5] Tomoya Yamakawa, "Prospective Stories and Engineering Trend in Automotive Society", MITSUBISHI DENKI GIHO, Vol.93, No.5, pp. 274 – 279, 2019

## Chapter Two: Superiority of Vehicle to Vehicle Communications

### 2.1 Background

Automated driving cars will operate on public roads in the near future. Automated driving cars are required to operate in a highly reliable and safe manner, resulting in lower passenger stress, as the passenger will entrust the driving to the car. There are several studies on the behavior of automated driving cars [2-1], [2-2]. But these studies are based on the relationships among automated driving cars. In the case of an automated driving car operating on a public road, the policy for co-existence with the prioritized vehicles, e.g., ambulance, should be considered. The author believes that automated driving cars should give way to an ambulance in the same manner as manual driving cars, even if the traffic signal is green when the ambulance enters an intersection on a red traffic signal. It is desirable for automated driving cars to recognize an approaching ambulance at the earliest possible time in order to take the above described action. As a method of recognizing an ambulance, it is conceivable to use siren sound, rotating red lights and vehicle to vehicle communications. Each method has the own specific features and limitations.

This chapter describes the desirable detection methods which automated driving cars should be equipped with, and compares each method. In Sec.2.2, actual data from manual driving car deceleration, velocity and position during an encounter with an ambulance is described. In Sect.2.3, the deceleration model is introduced, showing the expected behavior of the automated driving car. In Sect.2.4, the stopping distance from the time of recognition to the time of the stop is considered using the above deceleration model. In Sect.2.5, data of the detective distance are illustrated for three recognition methods (siren sound, rotating red lights, vehicle to vehicle communication). In Sect.2.6, a comparison and

consideration of the recognition methods is conducted based on the discussion in Sects.2.4 and 2.5, and proposal is made regarding the desired recognition method that is available to achieve the expected deceleration behavior. In Sect.2.7, the conclusions are presented.

## 2.2 Deceleration of Manual Driving Car at an Intersection

Figure 2-1 shows an actual intersection located in Motoyama, Nagoya City. At this intersection, several sensors are installed on the roadside to detect the vehicles in the lanes and their positions. The sensor information is broadcast to nearby cars through a roadside wireless unit. Information on an approaching ambulance is transmitted via vehicle to vehicle communication. The 54 ambulances of the Nagoya City Fire Department have wireless units for vehicle to vehicle communications and perform their mission every day. The location, Motoyama, is near a hospital, and ambulances frequently pass through the intersection. Data on 20 events was saved during 14 experiment days at times when an ambulance entered the intersection with a red traffic signal.

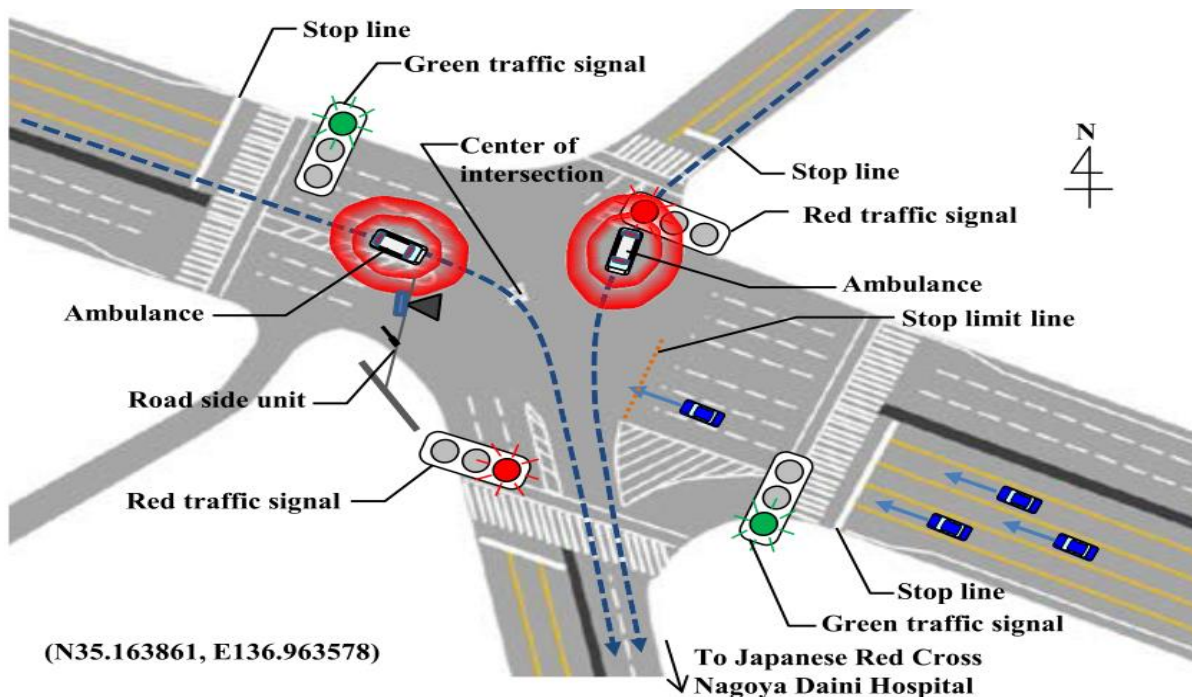

Fig. 2-1 Overview of the Motoyama intersection and example of an ambulance route

Figure 2-2 depicts an ambulance entering the intersection with a red traffic signal.



Fig. 2-2 A scene of an ambulance entering the intersection

Figure 2-3 shows examples of vehicle location information acquired through vehicle to vehicle communication and vehicle to infrastructure communication. The vertical axis of the graph shows the distance from the intersection center, and the horizontal axis shows time. The upper graph shows the position of the ambulance, and the lower graph shows the positions of cars in the opposite lane.

Cars 1, 2 and 3 are passing through the intersection. Car 4 detects the ambulance and slows down and stops even if the traffic signal is green. The 20 data collected were divided into four groups corresponding to the emergency grade to stop in front of the intersection, based on the distance to the stop limit line and the velocity at the start of deceleration.

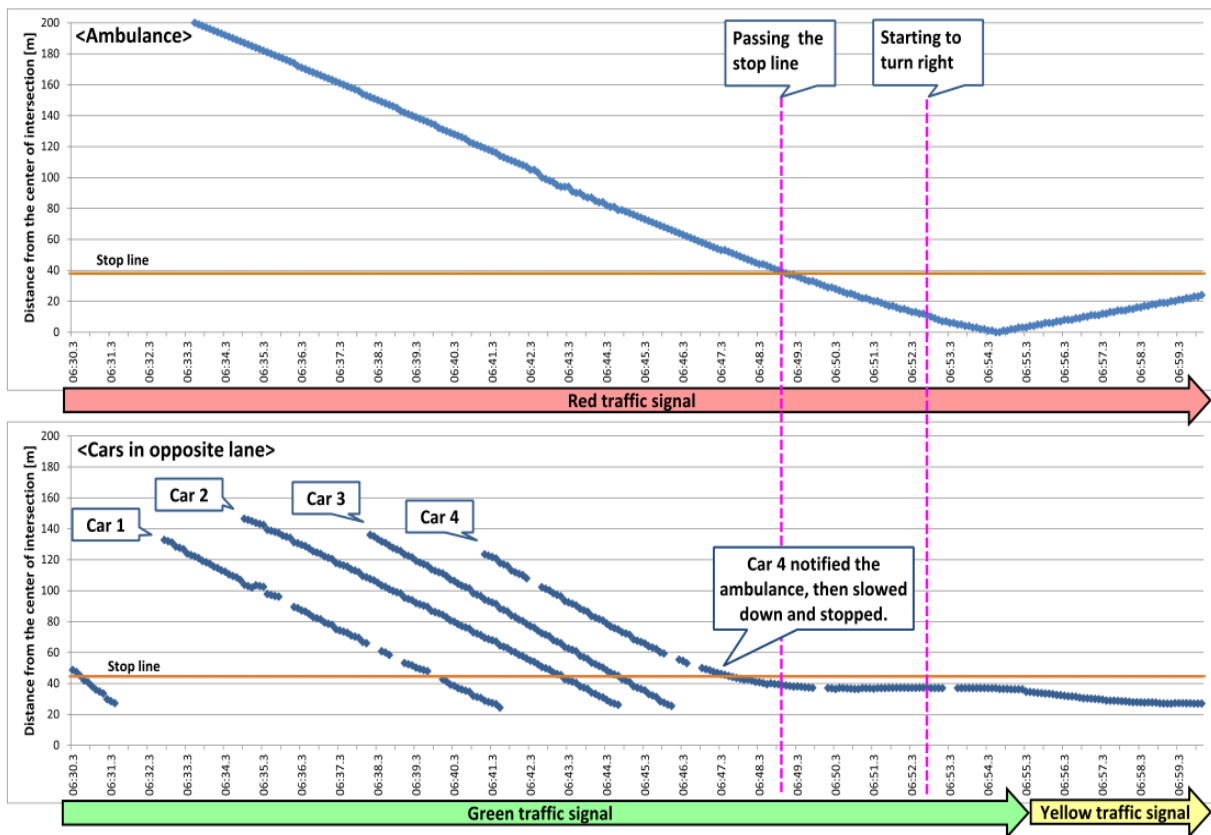

Fig. 2-3 Examples of vehicle movement data

Figure 2-4 shows the deceleration curve of the highest emergency grade among the groups. Figure 2-5 illustrates the deceleration curve of the lowest emergency grade among the groups. For descriptive purposes, deceleration is expressed as a negative value and maximum deceleration means the maximum value of the absolute value. The deceleration curves are obtained by differentiating the velocity curve, which is represented as a polynomial approximation of the collected data. Figure 2-4 indicates that the maximum deceleration is less than  $-4\text{m/s}^2$  even in the high. It is possible that this is the result of the necessity to avoid over deceleration due to the short distance to the stop limit line of the intersection. Looking at Figure 2-5, the maximum deceleration is about  $-1.5$  to  $-2.5\text{m/s}^2$  in the lowest emergency grade group.

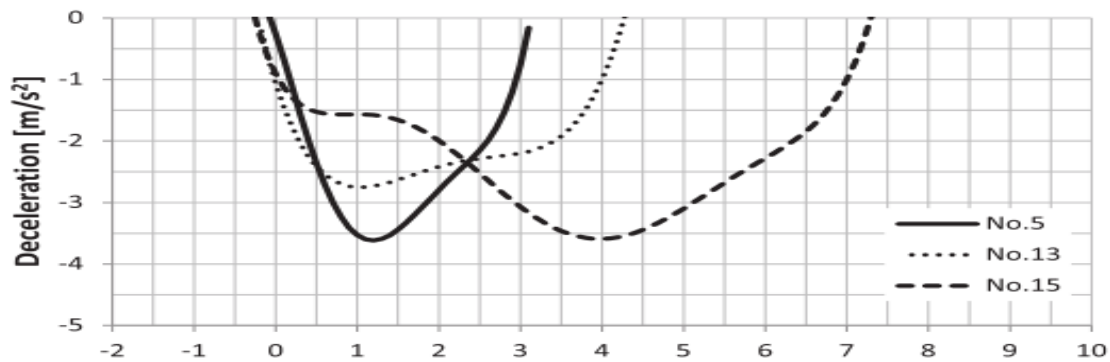

Fig. 2-4 Rough stop examples

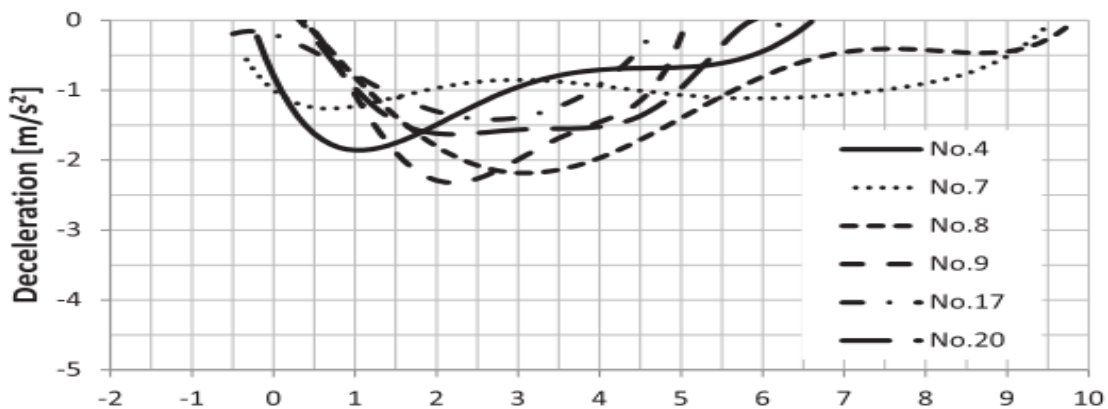

Fig. 2-5 Smooth stop examples

## 2.3 Deceleration Model of Giving Way to an Emergency Vehicle

### 2.3.1 Requirements

Automated driving cars should be smoothly controlled to minimize uncomfortable feelings by passengers. In the case of giving way to an ambulance and stopping, it is expected that an automated car will be controlled to avoid extreme deceleration or rapid acceleration changes. Because sudden deceleration has a great impact on following cars, in accordance with the circumstances, it may be acceptable to not give way to another vehicle. On the other hand, insufficient deceleration makes it impossible for the car to stop by the stop line or requires a long stopping distance. Such action can have an adverse effect

on nearby cars. Therefore, deceleration should be moderate. In this section we will consider a deceleration model to give way to an ambulance. Based on the deceleration curve of the general vehicle described in Sect. 2.2, the requirements for the deceleration model were examined. As a result, four requirements were derived.

- (1) This deceleration model is adopted in which the maximum deceleration is determined according to the velocity and the distance to the stop line at the timing of starting deceleration.
- (2) In the case where the maximum deceleration becomes  $-2\text{m/s}^2$  or less to stop at the stop line, the velocity shall be maintained until the deceleration start position that can be stopped with the deceleration curve where the maximum deceleration becomes  $-2\text{m/s}^2$ .
- (3) In the case where the maximum deceleration exceeds  $-4\text{m/s}^2$  to stop at the stop line, do not decelerate and go over the intersection.
- (4) The deceleration curve has a continuous change in its value, and its maximum deceleration is in the first half.

### 2.3.2 Application of IDM (Intelligent Driver Model)

We considered using IDM (Intelligent Driver Model) as a deceleration model for the behavior to give way. IDM is one of continuous follow-up traveling models and is often used for traffic flow simulation on expressways and urban roads [2-3] – [2-5]. In the IDM, the instantaneous acceleration is expressed by Eq. (2-1).

$$\frac{dv}{dt} = a \left\{ 1 - \left( \frac{v}{v_0} \right)^\delta - \left( \frac{s^*(v, \Delta v)}{s} \right)^2 \right\} \quad (2-1)$$

The desired distance between preceding car,  $s^*$  is,

$$s^*(v, \Delta v) = s_0 + vT + \frac{v\Delta v}{2\sqrt{ab}} \quad (2-2)$$

Table 2-1  
Parameters of IDM

Parameter	unit	Explanation
$a$	m/s <sup>2</sup>	Maximum acceleration
$b$	-m/s <sup>2</sup>	Maximum deceleration
$v_0$	m/s	Desirable velocity
$\delta$	-	Accelerative exponent
$v$	m/s	Current velocity
$\Delta v$	m/s	Velocity difference between preceding car
$s_0$	m	Desirable minimum distance between preceding car
$s$	m	Distance between preceding car
$T$	s	Desirable headway time

Table 2-1 shows the IDM parameters. As a simple case, a vehicle decelerates and stops at the stop line. In this case, the desired minimum distance  $s_0 = 0$ , headway time  $T = 0$ , velocity difference  $\Delta v = v$ , and  $s$  is the distance to the stop line.  $s_0$ ,  $T$  and  $\Delta v$  are substituted into Eq. (2-2), then:

$$s^*(v, \Delta v) = \frac{v^2}{2\sqrt{ab}} \quad (2-3)$$

When Eq. (2-3) is substituted into Eq. (2-1), then:

$$\frac{dv}{dt} = a \left\{ 1 - \left( \frac{v}{v_0} \right)^\delta \right\} - \frac{1}{b} \cdot \left( \frac{v^2}{2s} \right)^2 \quad (2-4)$$

The first term of Eq. (2-4) is the acceleration item and the second term is deceleration term.



As the vehicle only decelerates in this case, only the second term is applicable. Finally, the instantaneous deceleration is described in Eq. (2-5).

$$\frac{dv}{dt} = -\frac{1}{b} \cdot \left(\frac{v^2}{2s}\right)^2 \quad (2-5)$$

Consider the specific example of the deceleration curve where the maximum deceleration  $b = -2\text{m/s}^2$ , initial velocity  $v = 40\text{km/h}$  (11.1m/s), and distance  $s = 100\text{m}$ .

The instantaneous deceleration is obtained by substituting the above values in Eq. (2-5).

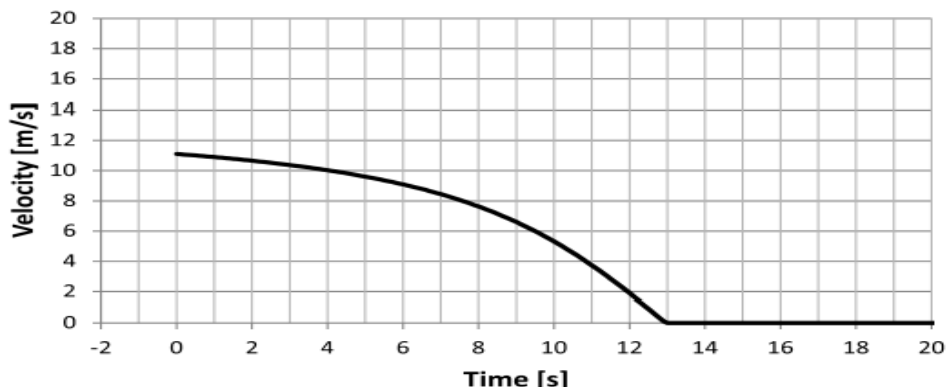

Fig. 2-6 Velocity characteristic with IDM

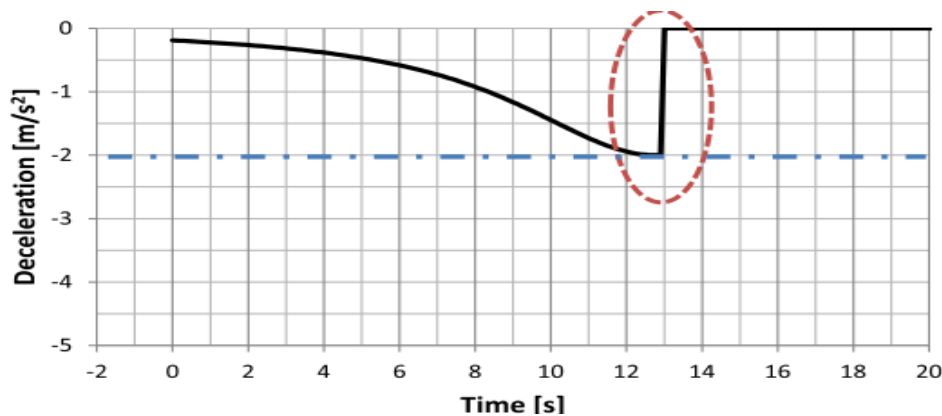

Fig. 2-7 Deceleration characteristic with IDM

The velocity at 100ms later and the position are obtained from the calculated instantaneous deceleration. Furthermore, the next instantaneous deceleration is calculated

in the same fashion. The characteristics of the calculated velocity and deceleration are shown in Figure 2-6 and Figure 2-7. A large change in deceleration does not satisfy the fourth requirement.

### 2.3.3 Modification of the IDM and Parameter Adjustment

From the results of Sect 2.3.2, it turned out that it is not desirable to use the original IDM model as it is. A model that produces a deceleration curve similar to actual data acquired is needed. Adjusting the parameters of the IDM and searching for parameters that produce a deceleration curve close to the actual data, the authors found that the two parameters are valid. One is the headway  $T$ , and the other is the exponent of the deceleration term. By inputting a positive value other than 0 to  $T$ , the deceleration curve continuously changes after reaching maximum deceleration. Also, by increasing the exponent of the deceleration term, the time to reach maximum velocity is shortened, and a curve close to the actual data is drawn. Only the second term, which is the deceleration term of Eq. (2-1), is taken out and the exponent parameter  $\beta$  of the deceleration term is introduced to obtain Eq. (2-6).

$$\frac{dv}{dt} = -a \left( \frac{s^*(v, \Delta v)}{s} \right)^{2\beta} \quad (2-6)$$

The desired distance from the preceding car,  $s^*$  is defined as Eq. (2-7) while retaining headway  $T$ .

$$s^*(v, \Delta v) = vT + \frac{v^2}{2\sqrt{ab}} \quad (2-7)$$

As a result of experiments with various initial conditions (velocity  $v_j$  at deceleration start and distance  $S_j$  to stop line), it was found that deceleration curves close to actual data can be obtained with  $T = 0.2$  and  $\beta = 4$ . However, the values of  $b$  are different, between the value

which has been set as the maximum deceleration so far and the value of the maximum deceleration of the deceleration curve when using Equations (2-6) and (2-7).

In order to obtain a deceleration curve with a relatively large maximum deceleration, it is necessary to input a larger value to  $b$ . Thereupon, a new parameter  $b'$  is introduced and  $b$  is determined by each case of  $b'$ .

Since the maximum deceleration is determined by  $v_j$  and  $s_j$ ,  $b'$  is initially approximated as an exponential function of  $s_j$ , and furthermore, in order to correspond to a certain range of  $v_j$ , a polynomial approximation of power exponent  $\gamma$  with  $v_j$  is performed. The approximate formulas are shown in Equations (2-8) and (2-9).

$$b' = 7500s_j^\gamma \quad (2-8)$$

$$\gamma = -0.0062v_j^2 + 0.2241v_j - 3.7875 \quad (2-9)$$

The introduction of this formula is described in Sec. 2.3.4.

The case of the value of  $b$  by  $b'$  is defined as the following conditional expression.

$$\text{Condition 1} \begin{cases} b' \leq 2.1 & \text{then, } b = 2.1 \\ 2.1 < b' \leq 8.0 & \text{then, } b = b' \\ b' > 8.0 & \text{then, doesn't stop} \end{cases} \quad (2-10)$$

The values of the parameters that have been set so far are shown below.

$$\begin{aligned} a &= 2.0 \\ b &= \text{Condition 1} \\ \beta &= 4 \\ T &= 0.2 \end{aligned}$$

In this way, we developed a deceleration model that improves the IDM and produces a deceleration curve close to the actual data.

### 2.3.4 Derivation of Parameter $b$ and $\gamma$

The author introduces the formulation of the maximum deceleration  $b'$  using Inductive methods.  $b'$  is the condition variable, it is handled as  $b = b'$  in this section. At first,  $T = 0.2$  and  $\beta = 4$  is fixed according to the shape of the curve. Then the formulation of the maximum deceleration  $b$  is conducted to make up from the value of distance to stop place  $S_j$  and velocity at deceleration start  $v_j$ .

Figure 2-8 shows the whole process of derivation of parameter  $b$  and  $\gamma$ .

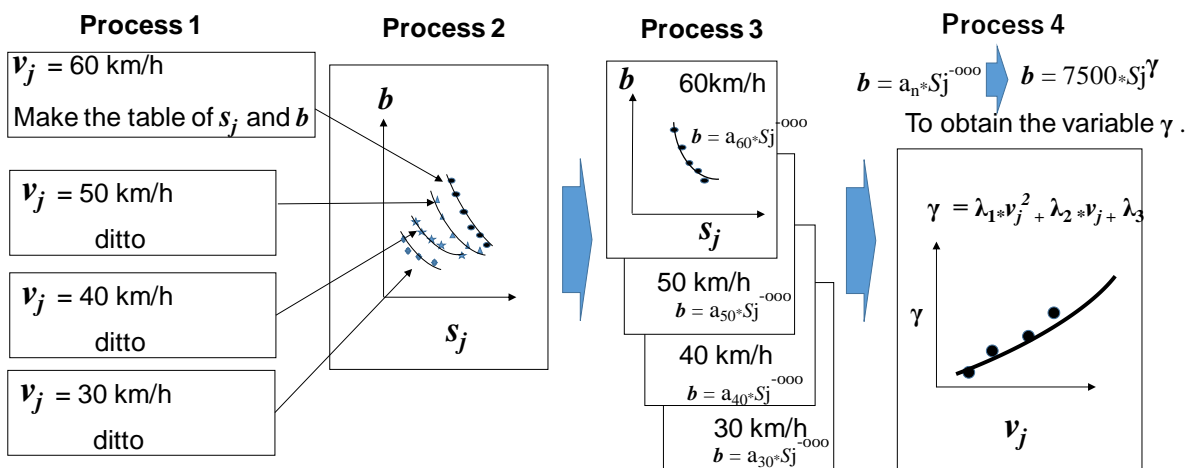

Fig. 2-8 Procedure of the derivation of  $b$  and  $\gamma$

In Process 1, the table of the reasonable maximum deceleration  $b$  vs. stopping distance  $S_j$  is made up.

In Process 2, for each initial velocity, the above described table is plotted in a sheet. It is figured whether the approximation of the unified expression is possible as the exponential function.

In Process 3, the approximate curve is fitted for  $v_j= 60$  km/h,  $v_j= 50$  km/h,  $v_j= 40$  km/h,  $v_j= 30$  km/h. Each exponential formula is obtained.

In Process 4, in order to express the unified exponential formula, exponential variable  $\gamma$  is approximated.

A reasonable deceleration  $b$  is obtained, that can be stopped without discomfort when the distance to stop changes at 10 m intervals.

For example, when  $v_j$  is 60 km/h,  $b$  has been fixed as a suitable value in reference to Figure 2-9 and Figure 2-10.  $b$  is the maximum deceleration, but because  $T$  and  $\beta$  are determined in advance, it is slightly different from the maximum deceleration of the actual curve particularly in small  $S_j$ . The values used in this case are shown in Table 2-2.

Table 2-2

Stoppable distance vs. Appropriate maximum deceleration

$S_j$ [m]	130	120	110	100	90	80	70	60
$b$ [-m/s <sup>2</sup> ]	2.1	2.1	2.1	2.4	2.9	3.6	4.5	5.9

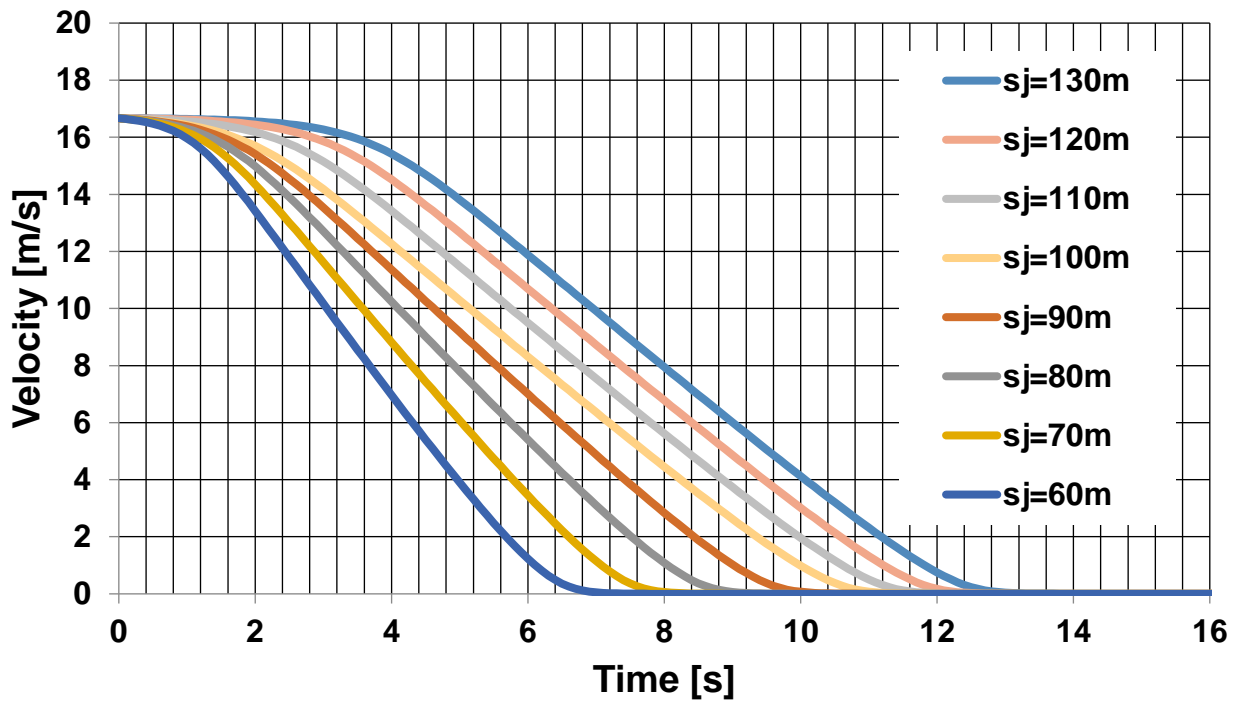

Fig. 2-9 Velocity for each Sj at 60 km/h

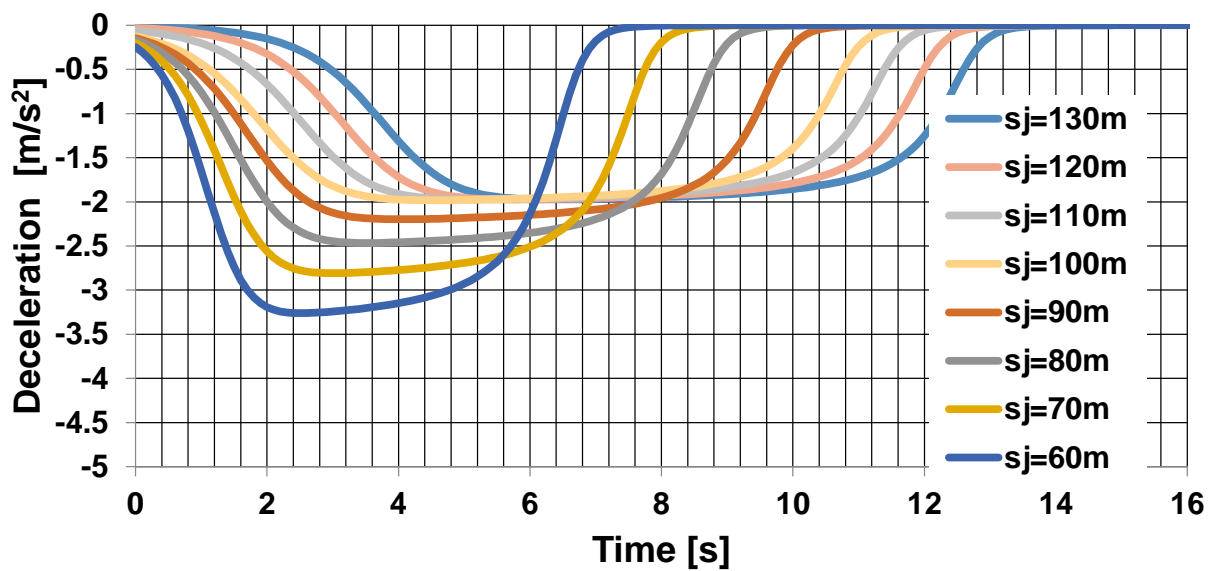

Fig. 2-10 Deceleration for each Sj at 60 km/h (Notice of a plus/minus sign)

Next, the same work was done for  $v_j = 50$  km/h,  $v_j = 40$  km/h,  $v_j = 30$  km/h.

A graph summarizing this is illustrated in Figure 2-11.

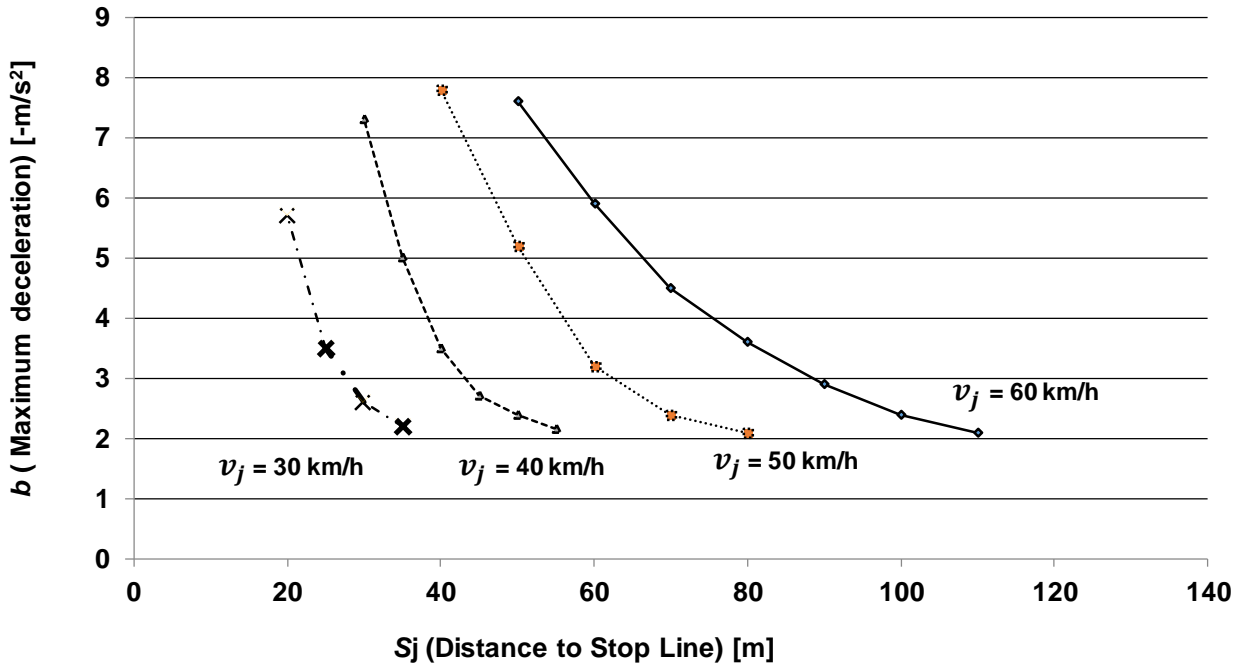

Fig. 2-11  $S_j$  vs.  $b$  for each initial velocity

This  $S_j$  vs.  $b$  relationship is desired to be described with a single relation expression.

First, each  $v_j$  appropriate curve was investigated.

Figure 2-12 shows the approximate curve and the approximate equation when  $v_j = 60$  km/h.

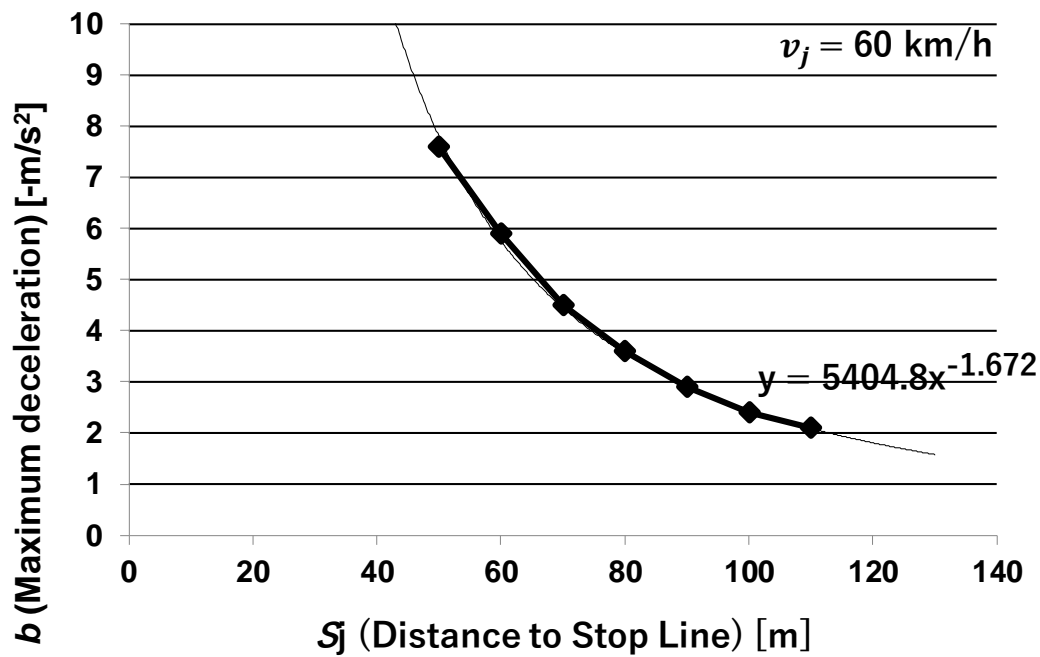

Fig. 2-12 Approximate curve at  $v_j = 60 \text{ km/h}$

Similarly, the case of  $v_j = 50 \text{ km/h}$  is shown in Figure 2-13, the case of  $v_j = 40 \text{ km/h}$  is shown in Figure 2-14, and the case of  $v_j = 30 \text{ km/h}$  is illustrated in Figure 2-15.

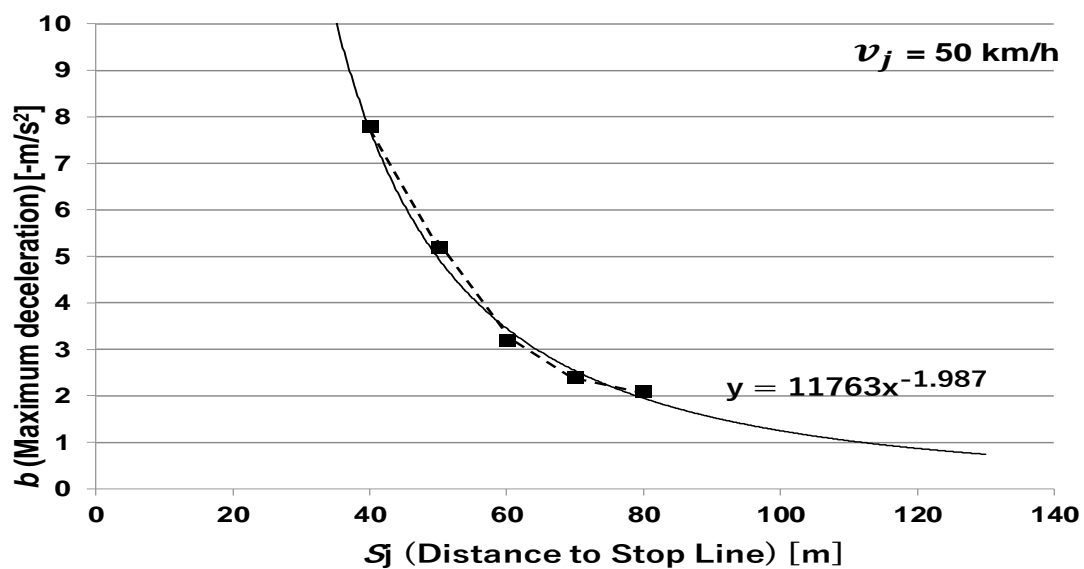

Fig. 2-13 Approximate curve at  $v_j = 50 \text{ km/h}$



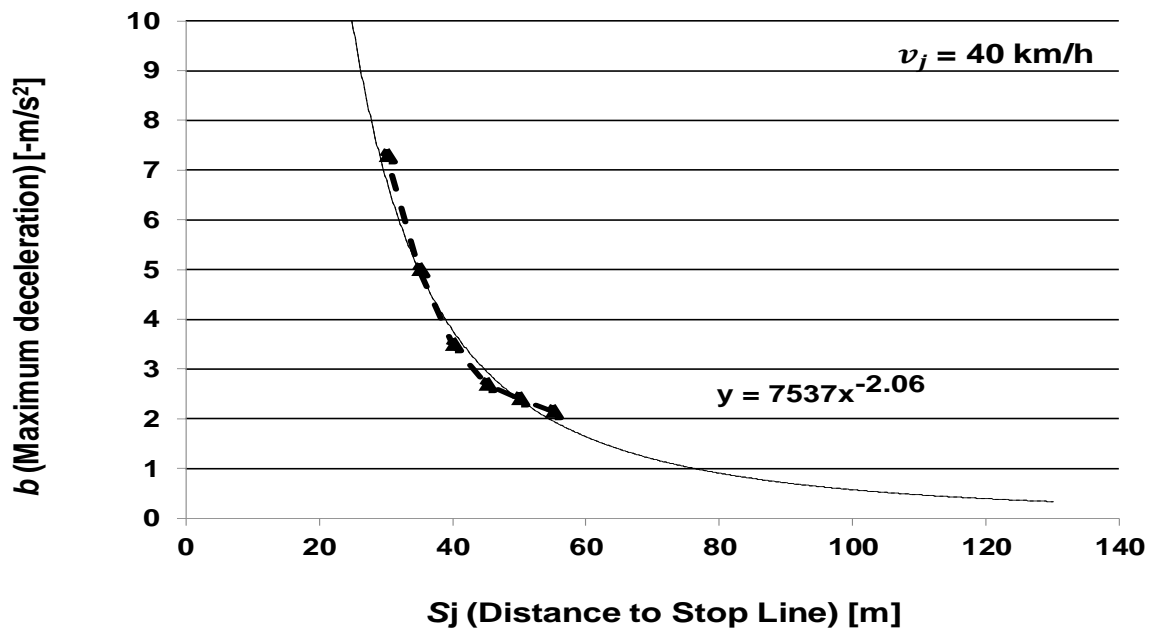

Fig. 2-14 Approximate curve at  $v_j = 40 \text{ km/h}$

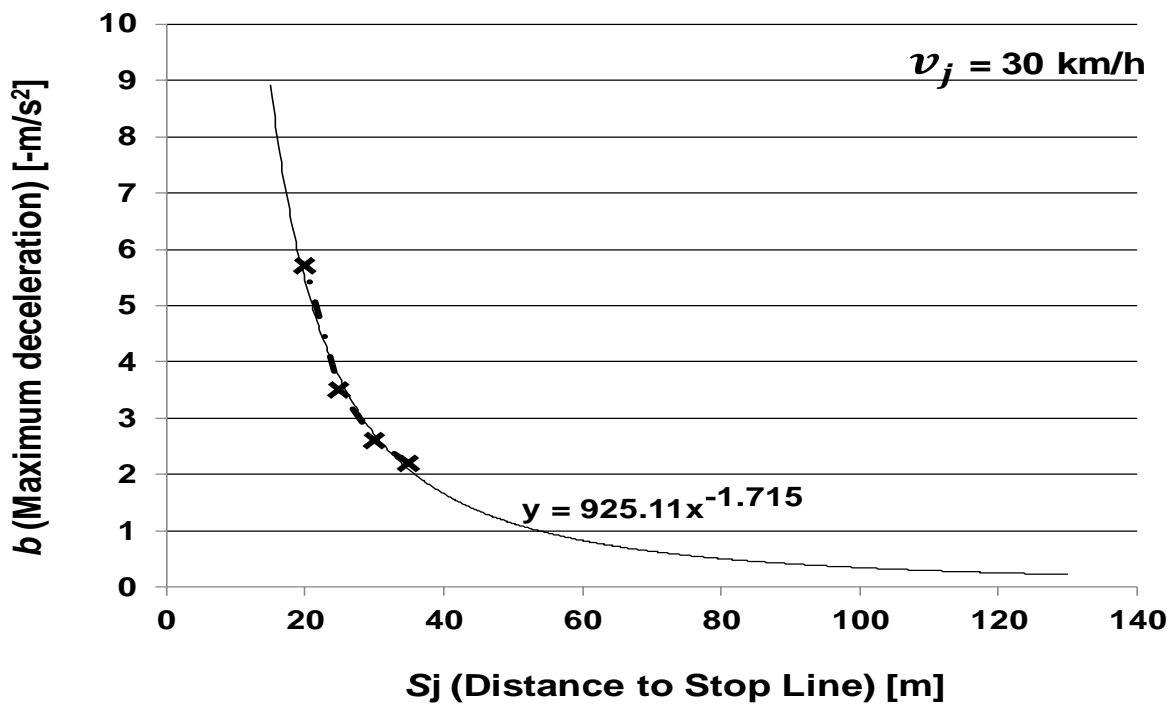

Fig. 2-15 Approximate curve at  $v_j = 30 \text{ km/h}$

From these approximation formulas, multiplied variable is set to one number and only exponential variables are adjusted to derive the functions close to four approximate curves.

The multiplied coefficient is set to 7500, which is the coefficient close to 40 km/h.

And  $\gamma$  of  $b' = 7500s_j^\gamma$  is sought for each velocity  $v_j$  at the start of deceleration.

For example, in the case of 60km/h,  $b = 5404.8 s_j^{-1.672}$  and  $b = 7500 s_j^\gamma$  could be assumed to be the same. Under the condition,  $\gamma$  is sought through several trials.

Table 2-3 shows the obtained exponent values.

Table 2-3 Initial velocity  $v_j$  vs. Exponential variable  $\gamma$

$v_j$ [km/h]	60	50	40	30
$v_j$ [m/s]	16.6	13.8	11.1	8.3
$\gamma$	-1.76	-1.87	-2.05	-2.35

A plot of  $v_j$  on the horizontal axis and  $\gamma$  on the vertical axis is shown in Figure 2-16.

Since these values depend on  $v_j$ , they are subjectively defined as the relation between speed  $v_j$  and maximum deceleration  $b$ . The exponential variable values obtained in this way are plotted in Figure 2-16, and  $\gamma = -0.0062v_j^2 + 0.2241v_j - 3.7875$  is derived from the quadratic polynomial approximation curve. That is the equation (2-9).

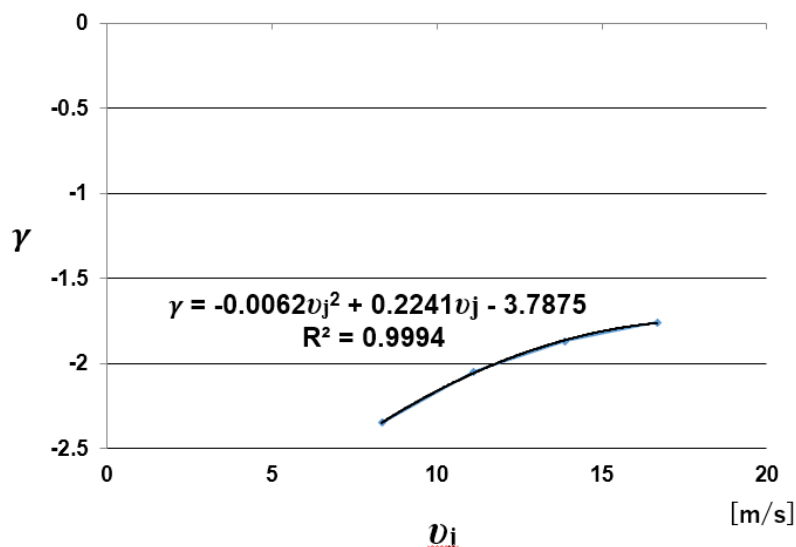

Fig. 2-16 Approximation formula of exponential part

### 2.3.5 Comparison of the Deceleration Model and Actual Data

A comparison of the deceleration model and the deceleration curve of the actual data were performed. The actual data to be compared is one datum (No. 15) in the group with the highest degree of urgency and one datum (No. 8) in the group with the lowest degree of urgency in Sect.2.2. The values of the velocity  $v_j$  at the start of deceleration and the distance  $s_j$  to the stop line are estimated from each data.

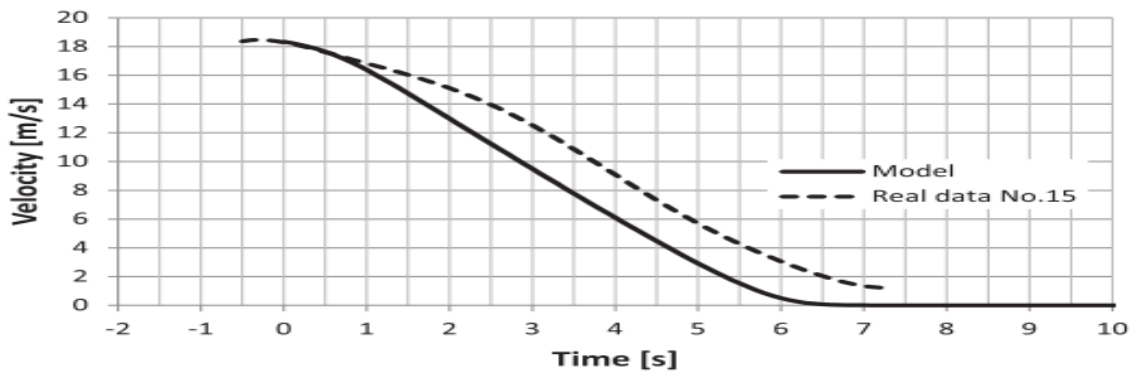

Fig. 2-17 Comparison of velocity characteristics between the model and the actual data No.15 ( $v_j = 18.3\text{m/s}$ ,  $s_j = 53.1\text{m}$ )

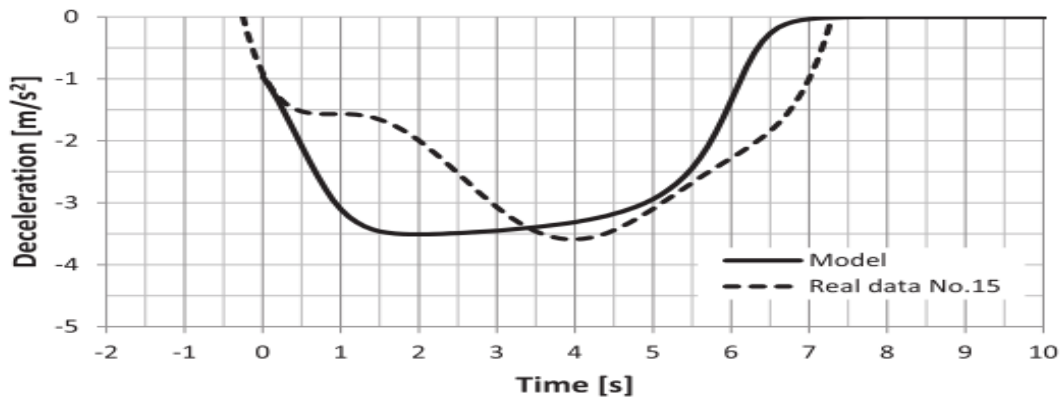

Fig. 2-18 Comparison of deceleration characteristics between the model and the real data No.15 ( $v_j = 18.3\text{m/s}$ ,  $s_j = 53.1\text{m}$ )

The comparison result of the velocity curve with the actual data No. 15 is shown in Figure 2-17 and the comparison result of the deceleration curve is shown in Figure 2-18. In addition,

the comparison result of the velocity curve with the actual data No. 8 is shown in Figure 2-19, and the comparison result of the deceleration curve is shown in Figure 2-20. The last part of the deceleration does not actually match because the vehicle does not stop and is slowing down. However, the characteristics of the curve and the maximum deceleration are very similar, and it can be said that this deceleration model is close to the actual data.

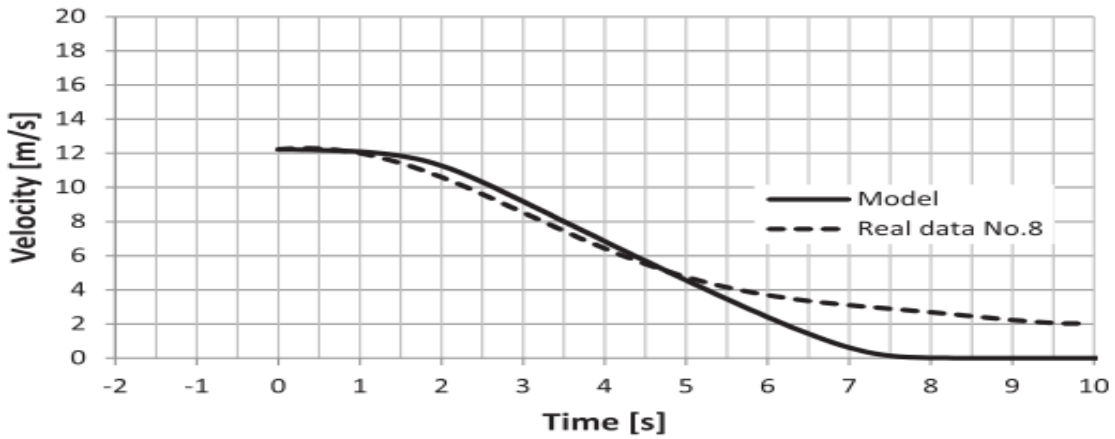

Fig. 2-19 Comparison of velocity characteristics between the model and the actual data No.8 ( $v_j = 12.2\text{m/s}$ ,  $s_j = 57.5\text{m}$ )

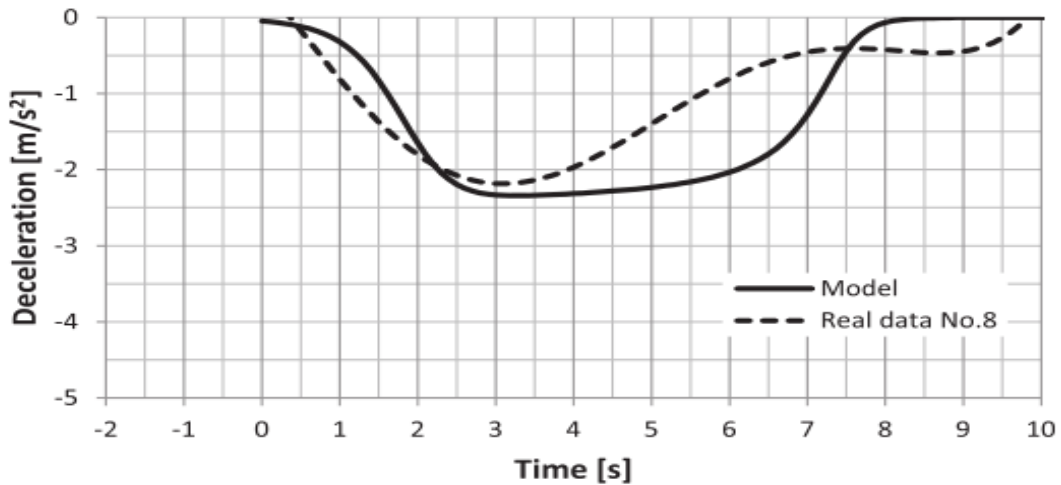

Fig. 2-20 Comparison of deceleration characteristics between the model and the actual data No.8 ( $v_j = 12.2\text{m/s}$ ,  $s_j = 57.5\text{m}$ )

## 2.4 Consideration of the Distance Required to Stop with the Desired Deceleration Behavior

In this section, using the deceleration model created in Sect.2.3, we examine the necessary distance until stop with the desired deceleration behavior. The most desirable deceleration behavior is a deceleration curve where the maximum deceleration is  $-2\text{m/s}^2$ , and this is referred to as a smooth stop. Considering the situation where there is no time margin, the deceleration curve that stops at the stop limit line before the intersection is the deceleration curve where the maximum deceleration becomes  $-4\text{m/s}^2$ , which is referred to as a rough stop. In this section, the necessary distance until stop (Velocity and deceleration become close to zero) is calculated for these two deceleration behaviors. The authors use the deceleration model formula in Sect.2.3 and search for the distance  $s_j$  to the stop line with a smooth stop and rough stop when the velocity  $v_j$  at deceleration start is 40km/h. As a result,  $s_j$  is 51.3m for a smooth stop and 27.5m for a rough stop. Figures 2-21 and 2-22 show the velocity curve and the deceleration curve at that time. Likewise,  $s_j$  with a smooth stop and rough stop is also found for cases where  $v_j$  is 30km/h, 50km/h, and 60km/h. Here, the delay time for processing is considered. Actually, even in a situation where it is necessary to immediately start deceleration at the time of recognizing an ambulance, the time of starting deceleration is not the same as the recognition timing, but after a delay time due to processing such as judgment. This delay time depends on the processing capability of the device to be installed. In this example, it is tentatively set to 1 second. The sum of the distance required to stop from the deceleration start and the distance traveled in 1 second is defined as the stop distance. Figure 2-23 shows the stop distance for the initial velocity of smooth stop and rough stop from 30 to 60km/h. In order to realize a smooth stop, a stop distance of 62.4m at a velocity of 40km/h and 91.6m at a velocity of 50km/h is required.

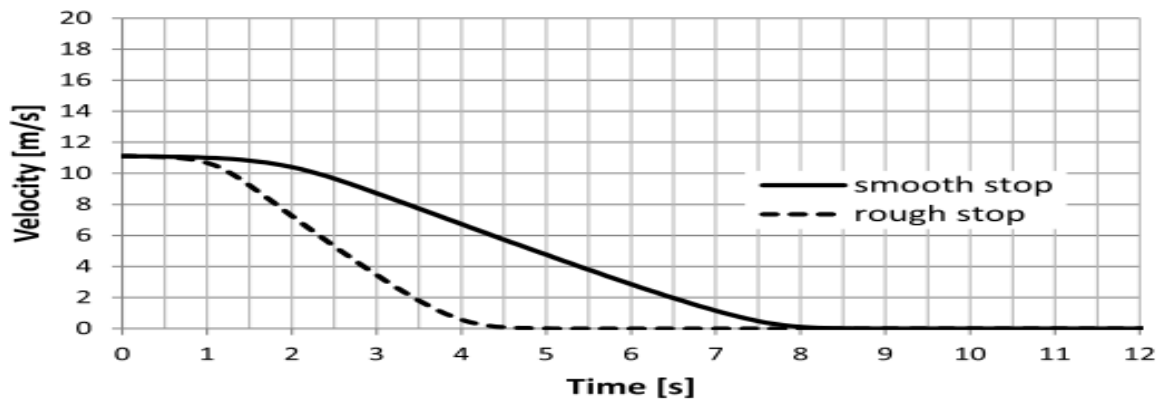

Fig. 2-21 Velocity characteristics under the conditions of a smooth stop and rough stop  
 $(v_j = 40\text{km/h})$

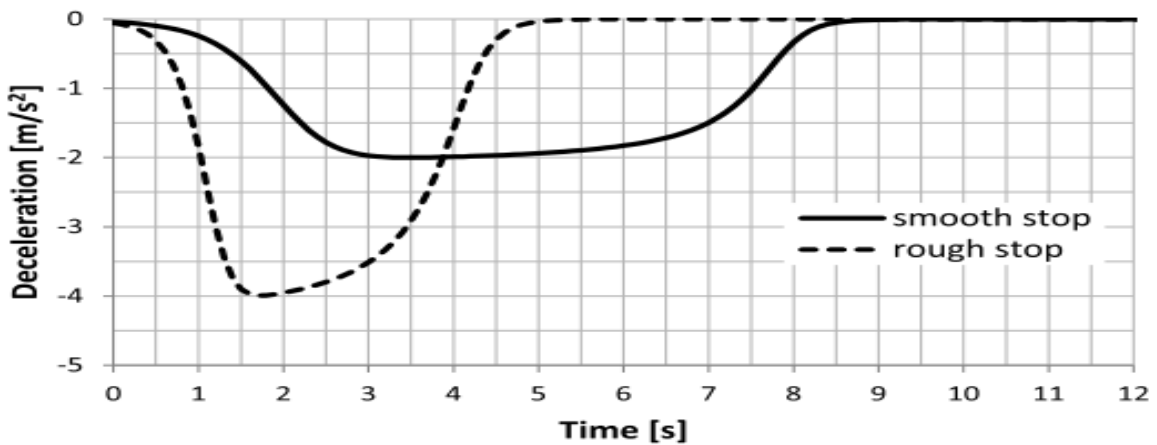

Fig. 2-22 Deceleration characteristics under the conditions of a smooth stop and rough stop  
 $(v_j = 40\text{km/h})$

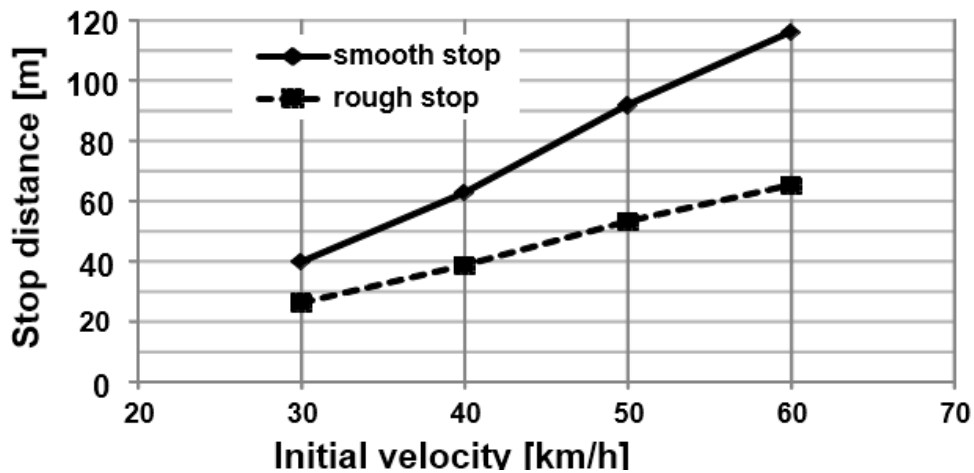

Fig. 2-23 Stop distance under the conditions of a smooth stop and rough stop

## 2.5 Confirmation of Recognition Distance for Each Recognition Method

### 2.5.1 Confirmation of Recognition Distance

It is assumed that the automated driving car is equipped with a plurality of sensors and communication means. It is supposed that the approach of an ambulance is also recognized by using those means. In this paper, we confirmed the three means of recognition rotating red light image for emergency car using camera, recognition of siren sound using microphone, and recognition by received information using vehicle to vehicle communication [2-6].

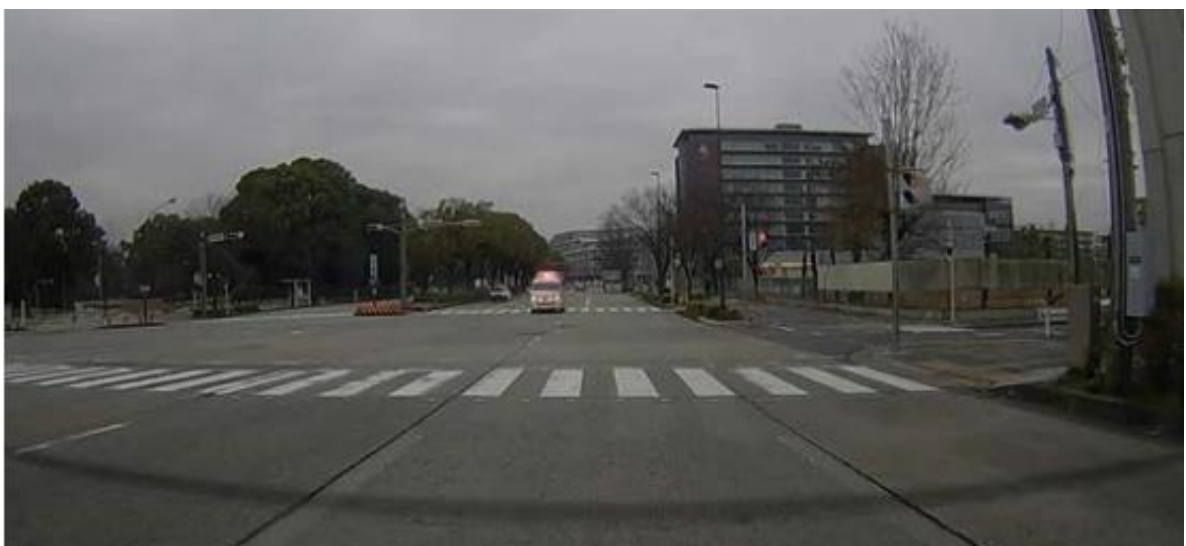

Fig. 2-24 Location 1 (N35.1863, E136.9047)



Fig. 2-25 Location 2 (N35.1465, E136.9648)

As a confirmation method, a test vehicle was operated on a road on which an ambulance frequently travels or stops near the intersection to obtain data. The image and sound were acquired using a drive-recorder, and received information was acquired via the vehicle to vehicle communication. Regarding images and sounds, automatic recognition by machine is desirable, but at this time, the experimenter determines the recognition timing subjectively, and the relative distance is calculated by referring to the position information log of the ambulance. As far as the received information is concerned, the message contains information indicating that the ambulance is traveling in emergency conditions and position information [2-7], and the relative distance at the time of receipt is obtained using this information. The vehicle to vehicle communication is based on ARIB STD-T 109 (700MHz band ITS) [2-8]. The location where the confirmation experiment was carried out was two places in Nagoya city. Ambulances in Nagoya city are equipped with vehicle to vehicle communication systems. Location 1 is an environment with good visibility on a straight road, and Location 2 is an environment with poor visibility near an intersection. Both are near hospitals, where there is a high probability of encounters with ambulances. Figures 2-24 and 2-25 show the images of each location.



Table 2-4 The distance to the ambulance at the recognition time at Location 1

	Camera	Siren Sound	V2V
Max.	374m	380m	570m
Min.	137m	107m	414m
Average	217m	228m	526m

Table 2-5 The distance to the ambulance at the recognition time at Location 2

	Camera	Siren Sound	V2V
Max.	49m	233m	302m
Min.	29m	70m	196m
Average	36m	168m	278m

### 2.5.2 Confirmation Result

The confirmation result at Location 1 is shown in Table 2-4, and the confirmation result at location 2 is shown in Table 2-5. Regarding the image recognition of the rotating red light for an ambulance, it is recognizable from an average of 217m ahead of Location 1 with good visibility. However, in Location 2, which is unfavorable due to obstacles such as buildings, it is difficult to recognize an ambulance entering from a cross road unless it approaches a distance of 36 m on average. Regarding recognition of siren sound, the average is 228 m at Location 1, and the average is 168m at Location 2. However, it is difficult to judge from which direction the ambulance is approaching, especially in places with poor visibility such as Location 2. Recognition using the vehicle to vehicle communication (V2V for short) is 526m on average on Location 1 and 278m on Location 2.

## 2.6 Consideration of the Recognition Distance and Recognition Method Required for Giving Way by an Automated Driving Car

Figure 2-26 and Figure 2-27 show the positional relationship between an ambulance and an automated driving car assuming that an automated driving car encounters an ambulance that has entered the intersection. Figure 2-26 shows the positional relationship when the ambulance approaches the intersection from the oncoming lane. An ambulance approaches the intersection from an orthogonal road in Figure 2-27.

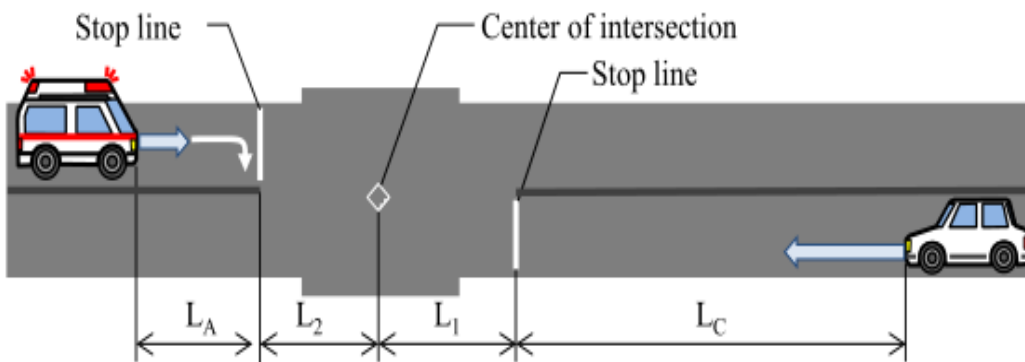

Fig. 2-26 The positioning between the ambulance and the automated driving car (opposite positions)

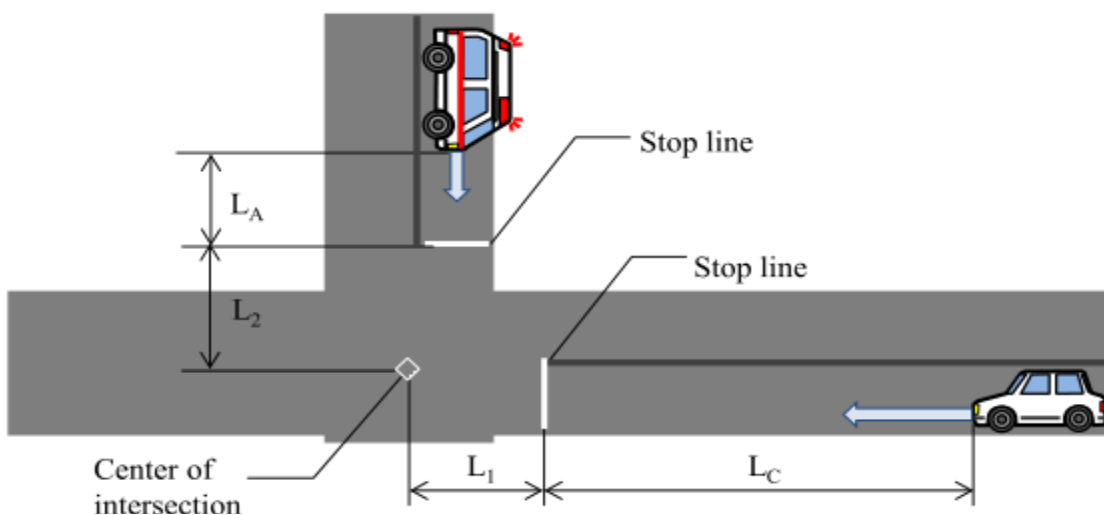

Fig. 2-27 The positioning between the ambulance and the automated driving car (crossing positions)

Table 2-6 Parameters for required recognition distance

Size of intersection {initial velocity of automated vehicle}		$L_1$ (= $L_2$ )	$L_A$	$L_C$
small {40km/h}	smooth stop	20m	34m	62m
	rough stop	20m	19m	39m
middle {50km/h}	smooth stop	30m	41m	92m
	rough stop	30m	22m	53m
large {60km/h}	smooth stop	40m	45m	116m
	rough stop	40m	24m	65m

$L_1$  and  $L_2$  in the figure indicate the distance from the center of the intersection to the stop line in each lane.  $L_C$  is the stopping distance of the automated driving car,  $L_A$  is the distance the ambulance travels between the time the automated driving car recognizes the ambulance and the time when it stops.

Table 2-7 Results of required recognition distance

	Size of intersection	Required recognition distance	
		smooth stop	rough stop
Opposite position	small	136m	98m
	middle	192m	135m
	large	241m	169m
Crossing position	small	98m	70m
	middle	141m	98m
	large	177m	123m

By using these values, the relative distance between the automated driving car and the ambulance is determined, and this is taken as the required recognition distance. Strictly, the value varies depending on the number of lanes of travel, but this is omitted here. Since  $L_1$  and  $L_2$  depend on the size of the intersection, in this study, three intersection sizes were set: small, medium, and large.  $L_1$  is set to 20m, 30m, 40m.  $L_2$  is set to the same value as  $L_1$ .  $L_C$  uses the value obtained in Sect. 2-4, but it depends on the speed of the automated driving car. Since the traveling velocity is assumed to be different depending on the road on which the vehicle is traveling, the running velocity is set according to the size of the intersection. The traveling velocity is set to 40km/h when the size of the intersection is small, 50km/h in the medium, 60km/h in the large.  $L_A$  changes according to the movement of the ambulance, but it is assumed that the ambulance is slowing down because it is about to enter an intersection while carrying a patient. Here, the average velocity of the ambulance is set to 15km/h, and  $L_A$  is then calculated. These values are shown in Table 2-6. Using the values in Table 2-6, the required recognition distances are calculated for opposite positions and crossing positions. The results are shown in Table 2-7. From Table 2-4 and Tables 2-5, Table 2-7, we consider the recognition method of ambulances. In an environment with good line-of-sight at the opposite position, except for the smooth stop at a large intersection, the mean value of all three methods satisfy the required recognition distance. However, with the minimum value, methods using cameras and microphones cannot satisfy the required recognition distance for a smooth stop at a medium intersection or rough stop at a large intersection.

Also, in an environment with poor visibility in a crossing position, recognition with a camera cannot satisfy the requirements under all conditions. With the method using a microphone, although on average the requirements were satisfied except for smooth stop at a large intersection, the minimum value cannot be satisfied under many conditions. With the method using the V2V communication, the requirement is satisfied under all the conditions even in

the minimum value in both the opposite position and the crossing position. Confirmation of cognitive distances using the cameras and microphones in Tables 2-4 and 2-5 is done subjectively by humans. If the automatic recognition technology using machines improves in the future, it is expected that the recognition distance will increase, but from the surroundings (for cameras, it is influenced by the weather and the time zone ambient light, for microphones, the surrounding noise), stable recognition of ambulances is considered a difficult task. Because the V2V communication is hardly affected by the surroundings and position information of an ambulance can be acquired, the approaching direction and the velocity can be estimated and it is advantageous for making the determination to give way.

## **2.7 Summary**

In order to give way when encountering emergency vehicles, which is one of the problems when automated driving cars travel on public roads, the recognition distances required based on the desired deceleration behavior were obtained and comparisons were made for three recognition methods. As a result, it was determined that the method using V2V Communication is most effective compared with the methods using a camera or a microphone. Since the data used for this study is under limited conditions, it is desirable to evaluate the data obtained at various places and conditions in the future.

## References

- [2-1] A. Reschka, J.R. Böhmer, F. Saust, B. Lichte, and M. Maurer, "Safe, dynamic and comfortable longitudinal control for an autonomous vehicle," Intelligent Vehicles Symposium (IV), 2012 IEEE, pp.346–351, 2012
- [2-2] R. Zheng, K. Nakano, S. Yamabe, M. Aki, H. Nakamura, and Y. Suda, "Study on emergency-avoidance braking for the automatic platooning of trucks," IEEE Trans. Intell. Transp. Syst., vol.15, no.4, pp.1748–1757, Aug. 2014
- [2-3] M. Treiber, A. Hennecke, and D. Helbing, "Congested traffic states in empirical observations and microscopic simulations," Phys. Rev. E, vol.62, no.2, pp.1805–1824, 2000
- [2-4] W.J. Schakel, B. van Arem, and B.D. Netten, "Effects of cooperative adaptive cruise control on traffic flow stability," Proc. 13th International IEEE Annual Conference on Intelligent Transport Systems, 2010
- [2-5] V. Milanés and S.E. Shladover, "Modeling cooperative and autonomous adaptive cruise control dynamic responses using experimental data" Transportation Research Part C: Emerging Technologies, vol.48, pp.285–300, 2014
- [2-6] DENSO REPORT, Development of V2V, V2I Communication Technology Toward the

Automated Driving Systems. <http://www.sipadus.jp/rd/h27/general.html>

[2-7] 700MHz BAND INTELLIGENT TRANSPORT SYSTEMS, Experimental Guideline for  
Vehicle to Vehicle Communication Message

[2-8] 700MHz BAND INTELLIGENT TRANSPORT SYSTEMS, ARIB  
STANDARD, ARIB STD-T109

[2-9] MIC, ICT for the Next Generation ITS, Basic Plan, 2014

## Chapter Three: Vehicle to Vehicle Communication with Trams

### 3.1 Background

Automated driving systems are being actively developed in various countries around the world. When an automated driving car travels on public road, unlike expressways and dedicated roads for automobiles, coexistence with a priority vehicle (such as an emergency vehicle, a tramcar) must be considered. Regarding emergency vehicles and automated driving cars, there is a prior study [3-1]. However, in case of tramcars and regular cars, the studies research has just begun [3-2], [ 3-3], and not much data is accumulated.

On the other hand, Light Rail Transit (LRT) is less expensive to install as subway and is environmentally friendly, so LRT is spreading to regional core cities. As far as tramcars are concerned, it is an important issue how to safely share the limited/dedicated road space with general vehicles and buses in order to reduce the traffic jam, namely increase efficiency of road space utilization. I think vehicle to vehicle communication (V2V, for short) is the best candidate to realize such wise traffic control [3-4].

In spite of these background, there are many cases where cars forcibly cross over the track area of a tramcar and cause an accident. Figure 3-1 shows an example of a dangerous situation when a regular car turns right and crosses the track even though a tramcar is approaching from behind.

In the future, sharing the situational information via V2V communication will be effective among pedestrians, general vehicles, buses and tramcars. As described above, we are expecting great things from V2V communication between tramcars and automated driving cars.





Fig. 3-1 A car crossing the track of a tramcar

In 2015, V2V wireless communication system has been put to practical use. However, in fact, there are few studies focusing on the feature of tramcars. Communication performance evaluation from the perspective of co-running with a tramcar had to be confirmed in an actual road environment.

When considering the spread of automated driving vehicle in the future, the performance data of vehicle to vehicle communication with a tramcar will be a valuable resource for the coexistence of trams, buses, and general vehicles.

In this paper, the author extracted a required specification assuming a case which is dangerous when an automobile crosses the track of a tramcar. And we examined whether the existing wireless system can satisfy its required specification. Specifically, a field

operational test was actually carried out to derive a mathematical formula expressing the stopping motion of the tramcar.

In addition, the author investigated the performance of existing wireless Communication system for vehicle to vehicle from two viewpoints: measurement at a fixed point (confirmation of communication capacity) and measurement in a running state (success rate of reception).

Considering the stopping motion of the tramcar and the performance of the existing radio system, it is confirmed that there is a potential to use in both the success rate of reception and the communication capacity even when used for the vehicle to vehicle wireless system which has already been put into practical use.

### 3.2 Requested Specification for Possible Use Cases

#### A. Crossing the track being difficult to see backward

When an automated driving car travels on public roads, the surrounding situation is acquired with the installed camera. Unlike the case of human driving, the camera is assumed to be installed in a fixed position, so the visible range is limited. When an automated driving car crosses the track of a tramcar, as a possible dangerous use case, it is assumed that a heavy vehicle follows up behind an automated driving car. Figure 3-2 shows an example of the situation in which an automated driving car crosses the track when it is difficult to see backward. In this case, the automated driving car temporarily stops before crossing the track and checks the safety of the rear side, but the heavy vehicle behind becomes an obstacle and it is impossible to see the track of the tramcar far to a distance.

After that, the automated driving car will attempt to run a proceeding distance and cross the track without recognizing the approach of the tramcar. In this situation, there is a danger that collision will occur because the deceleration of the tramcar approaching from behind will not be in time. Figure 3-3 is an image diagram of a scene in which there is a danger that an automated driving car collides with a tramcar on the track.

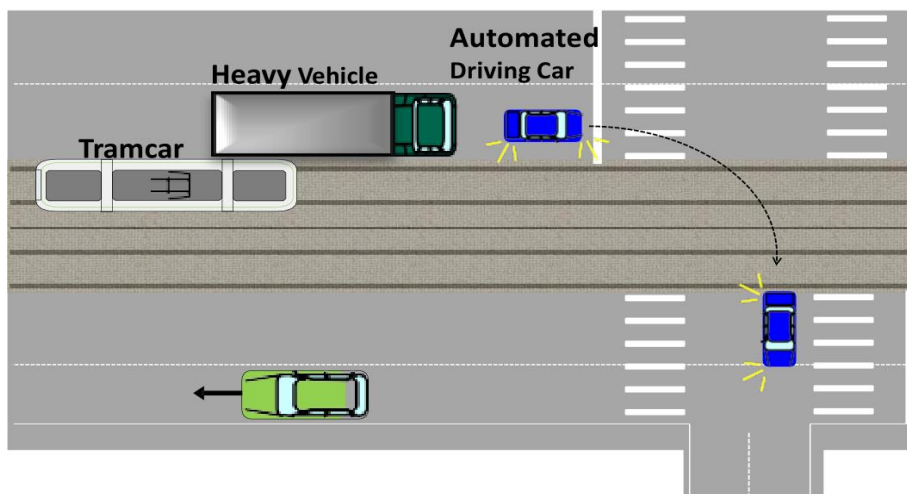

Fig. 3-2 An automated driving car crossing the tramcar track, its backward invisible

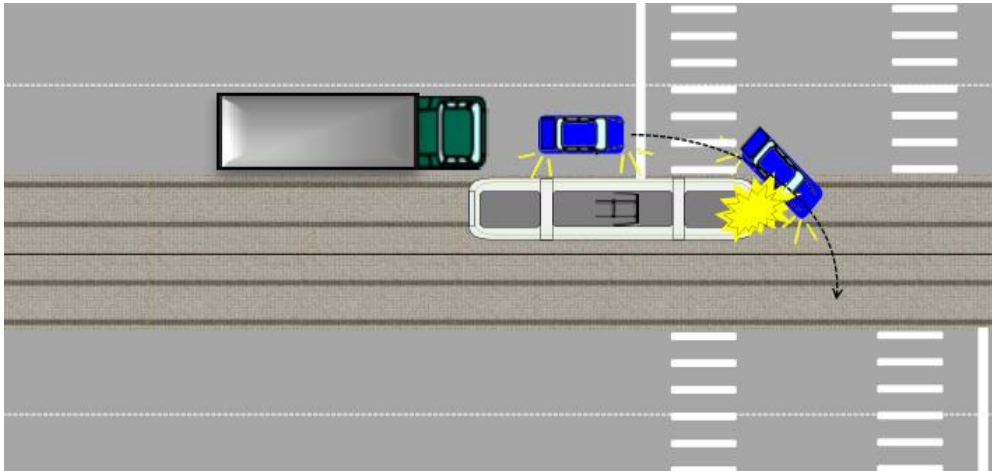

Fig. 3-3 Probable collision accident of tramcar and automated driving car

*B. Positional relationship being difficult to see backward*

Figure 3-4 shows the positional relationship among an automated driving car, a heavy vehicle and a tramcar in a situation when an automated driving car is having difficulty to see backward.

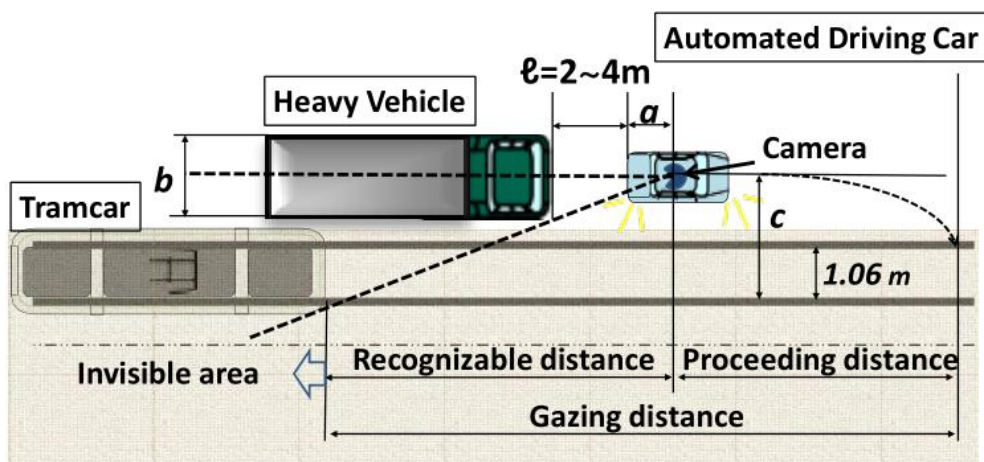

Fig. 3-4 Positional relationship in backward invisible

The automated driving car is temporarily stopped at the center of the lane in order to cross the track.

The automated driving car advances by the proceeding distance from the stop position and reaches the side-end of the track. The position of the automated driving car is the center of the lane and the proceeding distance is empirically about 12 m. Assuming a typical compact car, the distance from the center of the vehicle to the rear end is set to be  $a$ . Let the distance from the front end of a heavy vehicle to the rear end of an automated driving car be  $\ell$ . And let  $c$  be the distance from the position of the automated driving car to the right rail of the tramcar, and  $b$  be the vehicle width of the heavy vehicle. The specifications of the positional relation is set as shown in Table 3-1.

Table 3-1  
Specification of the positional relationship

---

$a = 2.315\text{m}$
$b = 2.3\text{m}$
$c \doteq 4.35\text{m}$
<b>Proceeding distance <math>\doteq 12\text{m}</math></b>

---

The actual measurement results are in Table 3-2.

Table 3-2  
Actual measurement results

---

$\ell = 2\text{m}$ : Recognizable distance = <b>18.5 m</b> Gazing distance = <b>30.5 m</b>
$\ell = 4\text{m}$ : Recognizable distance = <b>23.5 m</b> Gazing distance = <b>35.5 m</b>

---

When an automated driving car and a tramcar do not notice each other at all and the tramcar is not decelerating at all, the time to reach the place of collision is 3.7 to 4.3 seconds, because the average speed of the tramcar is regulated to be 30 km/h or less (the maximum speed is less than 40 km/h). It takes 5 to 9 seconds as measured for a car driven by a human to finish crossing the track of a tramcar. Let us say it is 7 seconds on average. The time period from 3.7 to 4.3 seconds, getting to a place where a tramcar collides, it is the time when a very dangerous situation occurs. It is necessary condition for an automated driving car to know the existence of a tramcar farther than the gazing distance considering the deceleration characteristics of the tramcar and the distance to the stop. The authors measured the deceleration characteristics and stopping distance of a tramcar by Field Operational Test in Hiroshima [3-9].

### **3.3 Outline of the Hiroshima Field Operational Test**

Field Operational Test (FOT) was conducted in Hiroshima City from October 2016 to late December in order to investigate the deceleration characteristics, stop motion and actual road traffic conditions of the tramcar described in the previous section. In the experiment, it is essential to exchange information of the mutual location and the speed of the tramcar when the tramcar and the general vehicle cooperate. Authors installed a V2V communication unit on the tramcar and the monitor car to acquire data. Figure 3-5 shows the experimental measurement system. Figure 3-6 shows the picture of the apparatuses. The experimental system consists of Wireless Unit, Data Logger, Inertial Sensor and Antennas. Inertial Sensor is used to obtain correction information for highly accurate position estimation [3-5].

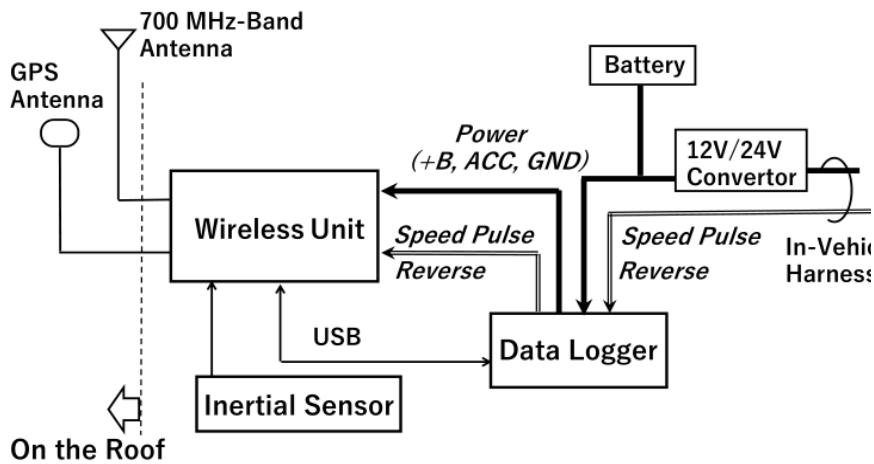

Fig. 3-5 Experimental measurement system

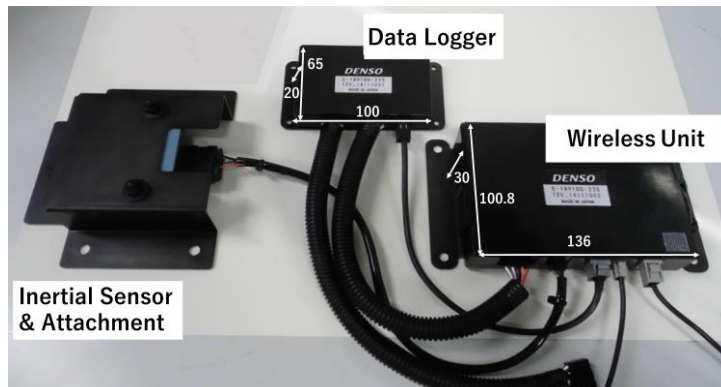

Fig. 3-6 Pictures of the equipment

In addition, we installed a driving recorder on the tramcar and recorded the video. The purpose of the experiment was twofold: the distance over which a tramcar can communicate and the radio communication quality at congestion. The deceleration and stop motion of a tramcar was carried out by the route which runs through the Hiroshima City Hall, Broadcast Station (NHK), Intersection KAMIYA, with four LRT type trains that are in regular operation, called on the No. 7 LINE. Travel data was collected in the section from A to B in Figure 3-7. The places where communication quality check was carried out are three; ① Hiroshima City Hall, ② Broadcast Station (NHK), ③ Intersection KAMIYA as shown in

Figure 3-7. From the video of the driving recorder, more than one scene was seen in each operation, in which the tramcar encounters the vehicle entering the track. Since the railway track is in the center region of the road, it can have a lot of situations when the general vehicle enters to cross the track. In case of an automated driving car, it seems that the standby waiting must be controlled in front of the railway track. The quality of radio communication during the radio congestion was measured by changing the communication traffic to 25, 70, and 75 by setting up to 75 radio units (vehicles) near the vehicle base of a tramcar instead of this route. The 75 radio units was the maximum due to budget limitations.

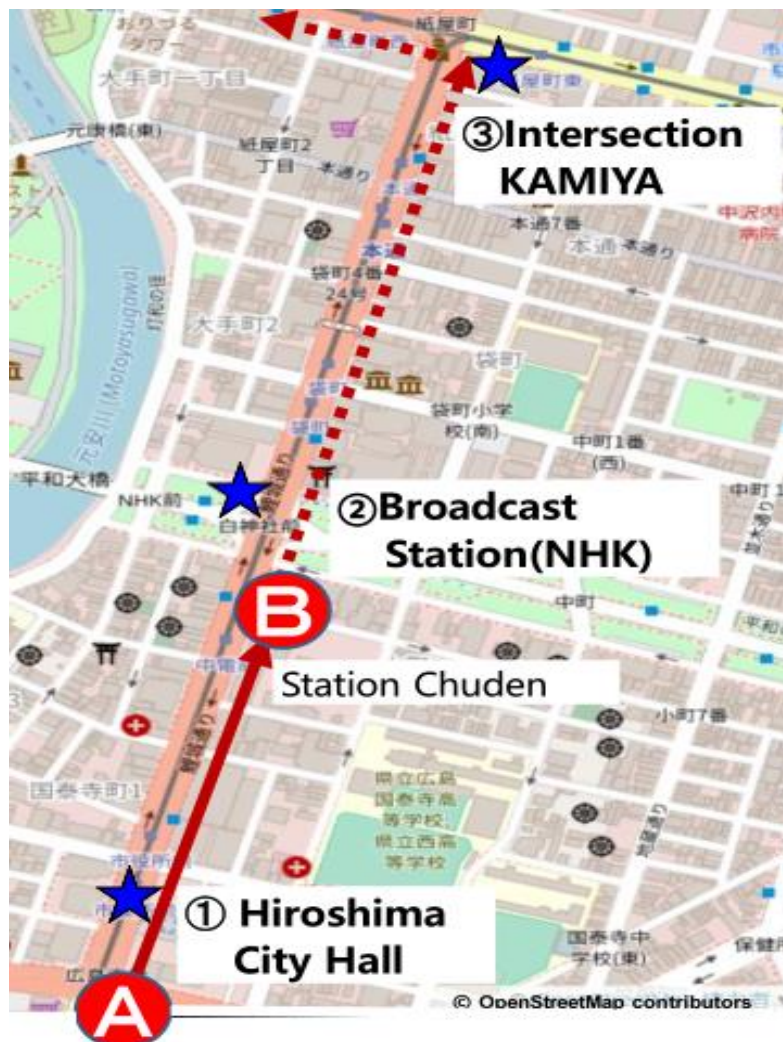

Fig. 3.7 Traveling route of tramcar and communication quality confirmation places



### 3.4 Tramcar Stop Motion

Figure 3-8 shows the data obtained during which the tramcar travels from ① to ②. The horizontal axis shows elapsed time. It was stopped for 0 to 18 seconds, then increased to 30 seconds and reached 35 km/h. It enters the deceleration mode in 40 seconds and stops at Hiroshima City Hall Station in 54 seconds. After keeping to stop till 70 seconds, it started traveling again and after increasing the velocity to 35 km/h, it began to decelerate again in 95 seconds and stopped at Station Chuden in 110 seconds.

During this period, the stopping operation is recorded twice. The velocity and the acceleration in the two stop operations are analyzed below.

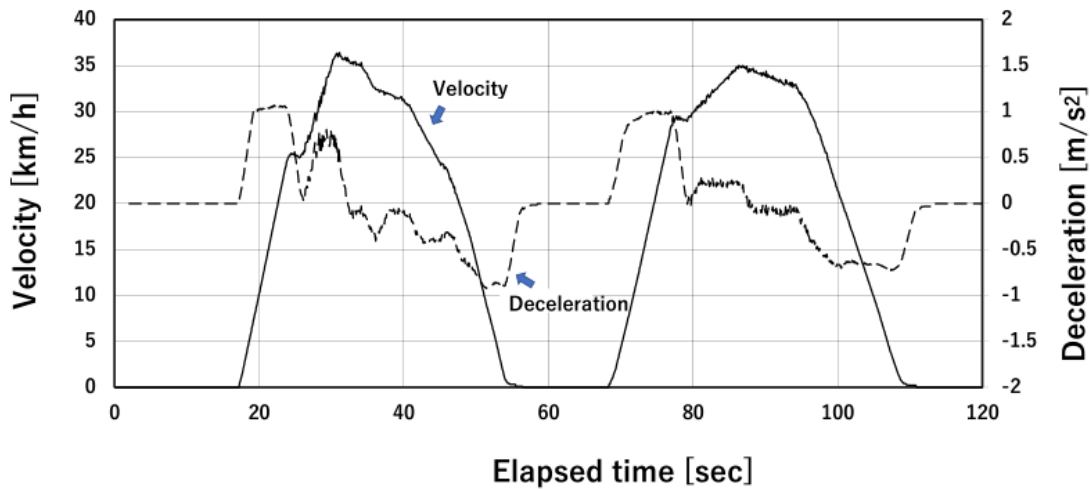

Fig. 3-8 Velocity and acceleration from point ① to ②

Figure 3-9 shows the deceleration data for stopping at Hiroshima City Hall Station.

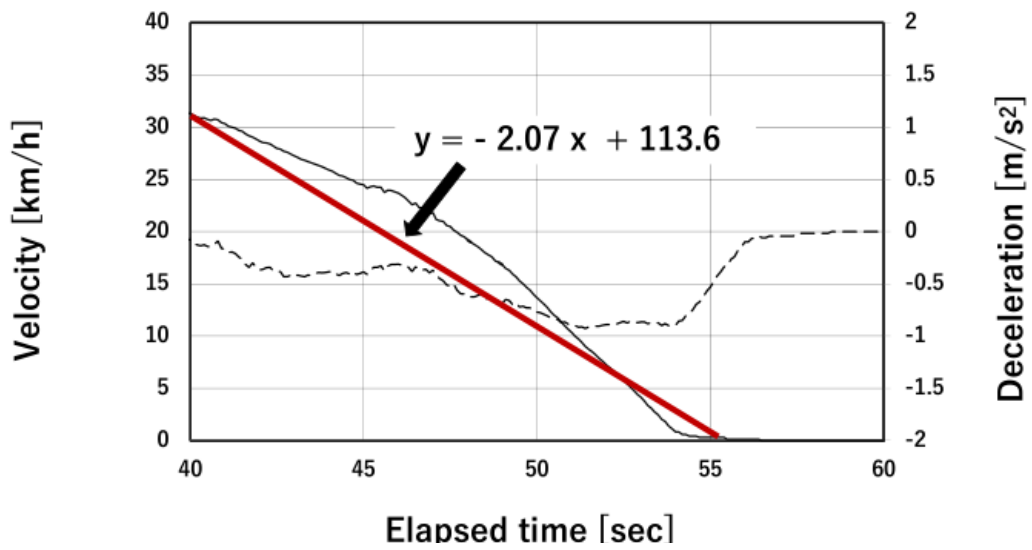

Fig. 3-9 Data obtained at Hiroshima City Hall Station

The velocity can be expressed by the mathematical formula  $y = -2.07x + 113.6$ .

The deceleration does not exceed  $-1 \text{ m/s}^2$  at the maximum. Figure 10 shows the deceleration data when stopping at Station Chuden.

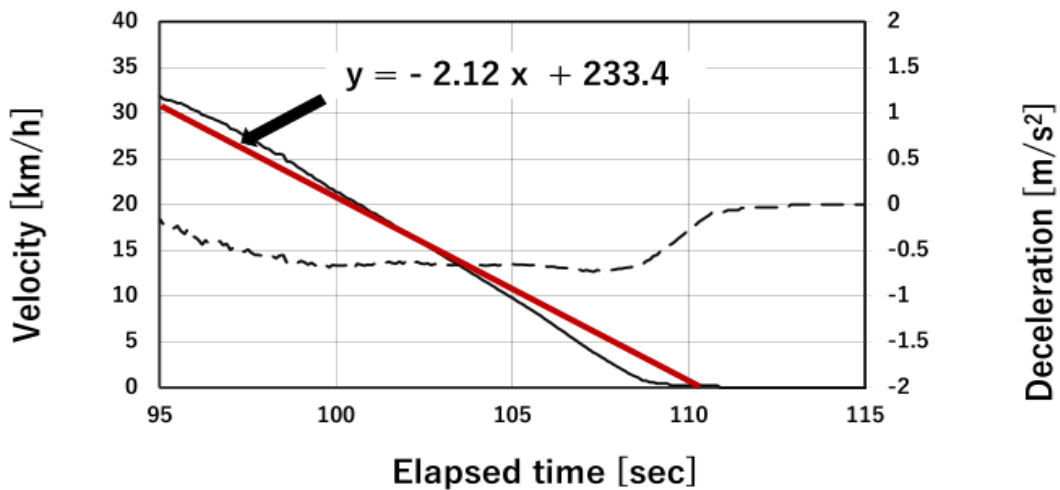

Fig. 3-10 Data obtained at Station Chuden

The velocity can be expressed by the mathematical formula  $y = -2.12x + 233.4$ . This time as well, the deceleration was maximum  $-0.75 \text{ m/s}^2$ . Both cases shown in Figure 3-9 and

Figure 3-10 are deceleration cases during commercial operation and tramcar stops at a value smaller than the jerk value (-0.08 g/s) produced by the security brake defined by the regulations. It is desirable for tramcar to follow this value, even when automated driving vehicles become widespread. The tramcar at deceleration is gently operated so that accidents such as passenger falling do not occur in the car. The slope coefficient (deceleration) of the mathematical formula is about -2.1 [km/h/sec] from the situations shown in the above two cases (Stopping at Hiroshima City Hall Station and Station Chuden). That is  $-2.1 * 1000/3600 = -0.583$  [m/s<sup>2</sup>]. The velocity  $v_t$  after  $t$  [s] can be expressed by the following equation, assuming that the deceleration beginning time is 0 [sec] and the velocity is  $v_0$  [m/s] at that time.

$$v_t = -0.583 t + v_0 \text{ [m/s]} \dots\dots\dots (3-1)$$

As the time to stop ( $t_{stop}$ ) is,  $t_{stop} = v_0 / 0.583$  [s], because it is  $v_t = 0$ .

Distance to stop ( $d$ ) is,  $d = 1/2 * v_0 * t_{stop}$  [m].

When the velocity of the tramcar at the start of deceleration is 30 km/h, the second speed is 8.33 m/s, so the time to stop is 14.3 sec and the stopping distance is 59.5 m. The stopping distance is different depending on the number of passengers on the tramcar, resulting in an error of about 15 %. In the examination of this time, referring to the actual data above, when the tramcar is traveling at the velocity of 30 km/h, the distance to stop is about 70 m ( $59.5 * 1.15 = 68.4$  m). This distance is the distance needed for a tramcar to recognize a vehicle crossing the track and to safely stop. It corresponds to the gazing distance as described in Section 3.2. Therefore, the cognitive distance is 58 m (70 m - 12 m) when the proceeding distance from the temporarily stopped point to the crossing point is 12 m. If there is no slack, the automated driving car and the tramcar will collide. In other words, the safe distance

cannot be obtained by visual recognition means such as a camera. V2V communication is considered as a promising candidate for collision avoidance means [3-6].

### 3.5 Performance of V2V Radio Communication System

The radio system used for the experiment is the radio system (ARIB STD T-109) [3-7] which has been put into practical use as "ITS connect service" for vehicle to vehicle / road to vehicle communication in Japan. The message used is ITS FORUM RC-013 [3-8]. Table 3-3 shows the radio specification.

Table 3-3  
Wireless system (ARIB STD T-109)

Items	Specifications
Center radio Frequency	760 MHz
Band width	9 MHz
TX power	10 mW/MHz
Rate	6 Mbps
Packet length	100 bytes
Antenna gain	2.15 dBi
Tx Control Period	100 ms

In an earlier study, the communication performance (communication distance, packet arrival rate) on the real road was reported [3-9].



Fig. 3-11 Antenna height in communication between car and car

For a packet arrival rate of 95% or more, the distance was reported to be about 140 to 180 m even when the number of communication vehicles was 77 cars.



Fig. 3-12 Packet arrival rate in communication between car and car

The packet arrival rate (PAR) is defined by the number of received packets in an arbitrary evaluation period and the number of packets not yet arrived using Equation 3-2.

$$PAR = N_x / (N_x + N_{lost}) \dots\dots\dots(3-2)$$

$N_x$ : Received packets

$N_{lost}$ : Packets not arrived

The data of vehicle to vehicle communication includes number information (increment counter) indicating the data transmitted order and is incremented each time transmission is performed. If all the packets can be received without loss, the increment counter of the received data increases by 1, but if packets cannot be received due to some circumstances, the missing of the increment counter occurs. When a missing occurs in the increment counter, it is determined that the packet has not been reached. In the case of tramcars and general vehicles, the antenna installed location is about 3.5 m on the roof of the tramcar (Figure 3-13). Although its communication performance is thought to be superior to that of car to car communication, it is considered that measurement is necessary quantitatively

because the communication environment is different resulting from the influence of surrounding buildings and the influence of road surface reflection.



Fig. 3-13 Antenna height during communication between tramcar and car

### 3.6 Measurements while Traveling

In traveling measurement, the distance between a tramcar and a regular car changes with each measurement. Therefore, the relative distance is calculated from the position information in the tramcar log and the position of the evaluating vehicle. The evaluation index is used with the 10 packets arrival rate with respect to the relative distance and the packet reception number of  $\pm 5$  m section. Also, in traveling measurement, it is difficult to perform multiple measurements under the same circumstances. Therefore, it is difficult to evaluate with accumulated packet arrival rate which is used in fixed location. Authors obtained the instantaneous packet arrival rate for the last 10 packets and the number of received packets in the  $\pm 5$  m section. The former index directly expresses communication characteristics, but it is rough in terms of accuracy. Although the latter index is not an index from the viewpoint of communication quality, it is an index close to the idea of accumulated packet arrival rate (the probability that it can be received even once during the specified section), and it is evaluated with these two indices. The evaluation criterion is set as "the past 10

packet arrival rate is 90% or more and the  $\pm 5$  m section packet reception number is 1 or more". The reason why the arrival rate is set to 90% is that momentary single packet loss is permitted as it cannot guarantee 100%. The reason why the number of received packets is 1 or more is a result in conformity with the idea of accumulated packet arrival rate of V2V which has been put to practical use. Figure 3-14 to 3-16 show the accumulated packet arrival rate and the relative distance at each measurement location.

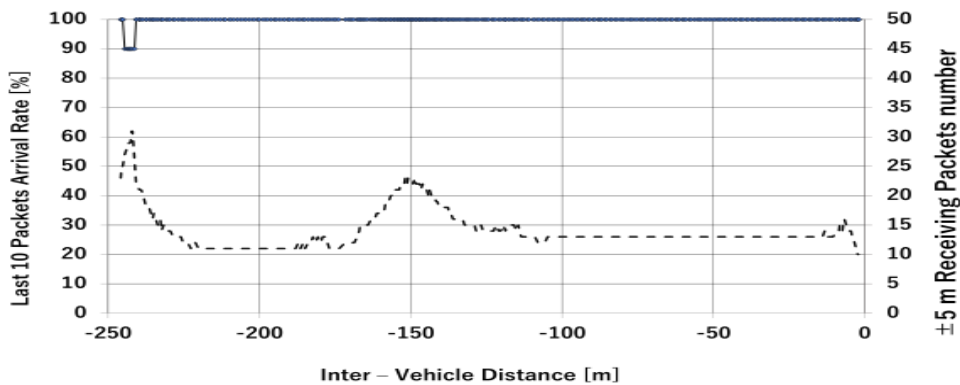

Fig.3-14 ① Around Hiroshima City Hall Station

The last 10 packets arrival rate in the vicinity of Hiroshima City Hall was 100% up to 230 m, and the number of packets received in the 5 m section was more than 10 packets. Here, the radio wave environment is good on a wide road.

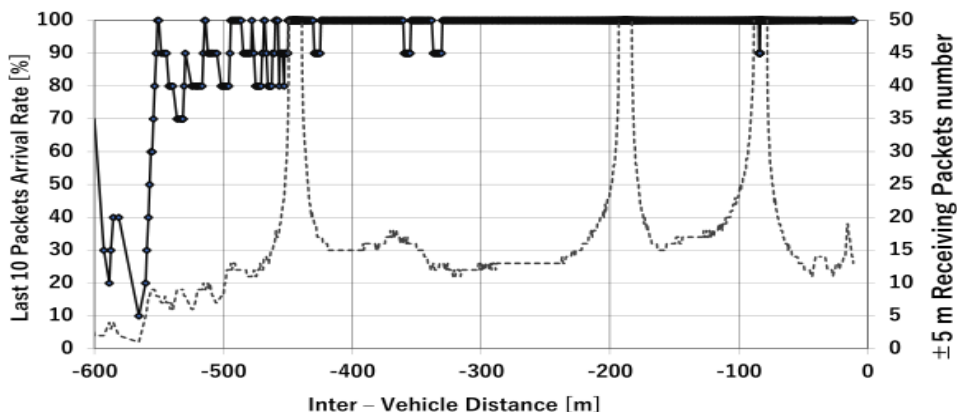

Fig. 3-15 ② Around Broadcast Station (NHK)

The last 10 packets arrival rate in the vicinity of Broad-cast Station (NHK) was 90% or more

up to 420 m, and the number of packets received in the 5 m section was 10 packets or more. It can be said that the radio wave environment is extremely good on a straight road with good line of sight.

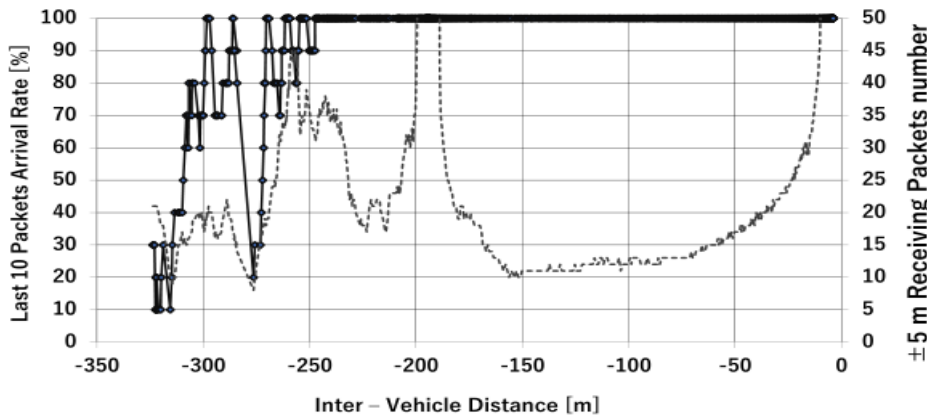

Fig. 3-16 ③ Around Intersection KAMIYA

The last 10 packets arrival rate at the Intersection KAMIYA was 100% up to 240 m, and the number of packets received in the 5 m section was 10 packets or more. The Intersection KAMIYA is a large intersection where the main road intersected, and the high-rise buildings are adjacent and it seemed to be a place not so good as a radio environment. However, the track of a tramcar is laid in the center of the road, and during the communication with a car on the same road, the influence of the reflection is minor and it can be said that it is a good radio environment. Since the maximum traveling speed of a tramcar is restricted to 40 km/h or less, in the case of transmitting based on 100 ms transmission period, nine packets are transmitted while traveling 10 m at a speed of 40 km/h. As a result, the number of packets received in the  $\pm 5$  m section being 9 or more seems to be that packet loss is hardly generated in all three locations.



### 3.7 Measurements in Fixed Location

Measurement at a fixed location is carried out by the stopping vehicle (evaluating car) that can measure and record the radio data. Also, we carried out 75 vehicles parked in the vicinity of the vehicle base. They are called high load vehicles with only the radio transmitting. The communication log is acquired in the evaluating car at the time when the tramcar equipped with V2V radio unit enters and exits the vehicle base. The evaluating car stops in the same location. Also, the same measurement is carried out by placing high load vehicles on the periphery (a point 40 m to 50 m away from the evaluating car) and changing the radio load to 0, 25, and 75 vehicles.

The relative distance is calculated from the position information of the tramcar in the communication log and the position of the evaluating car. The accumulated packet arrival rate with respect to the relative distance is used as the evaluation index. PAR (Packet Arrival Rate) is calculated from the number of transmitted packets and the number of received packets in the relative distance  $\pm 5$  m section with collecting the logged data encountering with a tramcar. Authors further obtained the accumulated packet arrival rate by using the following formula.

$$\text{Accumulated PAR} = 1 - (1 - \text{PAR})^k \dots\dots\dots (3-3)$$

The coefficient  $k$  is the number of packets that can be received while traveling in the predetermined interval, and the value of  $k$  is set to 5.1 this time. The value of  $k$  is the value required for safe driving support application in V2V between cars, for example, predetermined interval: 10 m, vehicle velocity: 70 km/h, transmission control period: 100 msec. While the tramcar is in operation, the velocity is not constant. Therefore, the number of transmitted packets differs depending on the relative distance (location). Authors

considered the measurement accuracy to be low at the location where the statistical parameter is small and treated the location where the parameter is less than 100 as "no data". Figure 3-17 shows the accumulated packet arrival rate and the relative distance (Inter-vehicle distance) when changing the load (the number of high load vehicles).

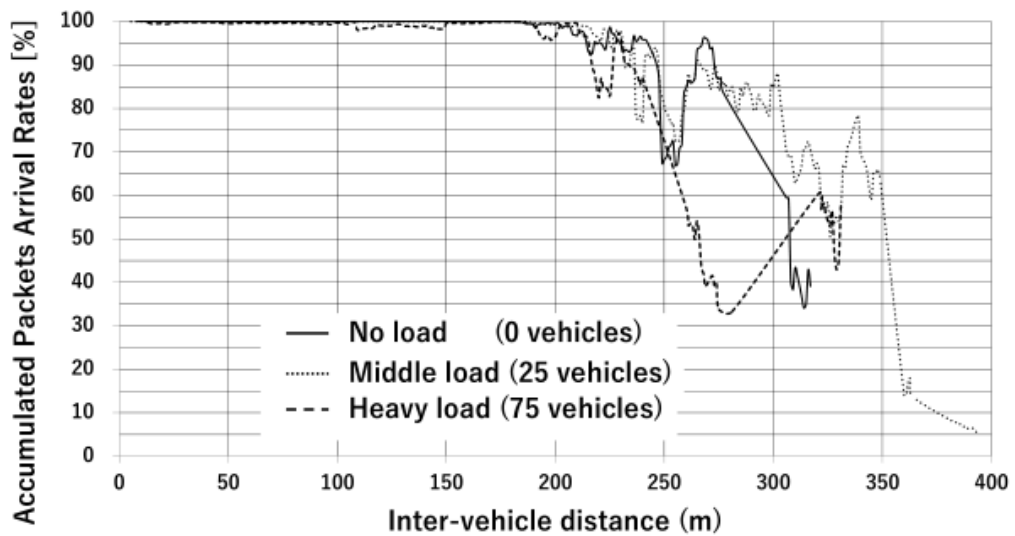

Fig. 3-17 Accumulated PAR at 0, 25, 75 vehicles

As the number of high load vehicles increase, the relative distance at which the accumulated packet arrival rate markedly decreases is getting short. However, even when it is 75 vehicles, the accumulated packet arrival rate is 95% or more within 200 m. (Slightly longer than the case between cars and cars) when the tramcar and the automated driving car communicate with each other, if the relative distance is within 200 m, it can be judged that there is no problem in communication performance even if there are around 75 vehicles.

### **3.8 Summary**

In order to realize safe driving for automated driving cars, it is studied to recognize surrounding environment and obstacles using a camera, laser radar and radio radar. However, there is no such thing as an almighty sensor. The latest technology is how to fuse the information of the above sensors. The V2V radio system can provide valuable information to automated driving cars, regardless of day and night or adverse weather conditions. Basic data on the communicable distance and the influence of radio waves congestion can be shown in this research. As a result of measurement while traveling and also measurement in fix location, communication quality (packet arrival rate) of 95% or more is realized even in a crowded situation (up to 75 vehicles) as long as the distance to the tramcar is within 200 m. The performance of the safe driving support V2V radio system that has been put to practical use in Japan is considered to have the potential to be used for cooperative control in the assumed use case of tramcars and automated driving cars.

## References

- [3-1] Hideaki NANBA, Yukihiro IKAMI, Kenichiro IMAI, Kenji KOBAYASHI, Manabu SAWADA, "An Advantage of the Vehicle to Vehicle Communication for an Automated Driving Car at the Encounter with an Ambulance", IEICE, Vol.E101-A, No.9, pp.1281-1289, Sep. 2018
- [3-2] Toshiyasu Tasaka, Takahiro Nakano, "Introduction of Mazda's Intelligent Transport Systems", Mazda Technical Report, No.31 (2013)
- [3-3] Masashi Yamamoto, Tomokazu Okugi, Yohei Iwashita, Haruki Okazaki, Haruhisa Kore, Tomonori Hasegawa, "Functionality Tests of Advanced Safety Vehicle Using Vehicle-to-Tram Communication on Hiroshima Public Roads", Mazda Technical Report, N0.32 (2015)
- [3-4] Michael R. Hafner, Drew Cunningham, Lorenzo Caminiti, Del Vecchio, "Cooperative Collision Avoidance at Intersections: Algorithms and Experiments", IEEE TRANSACTIONS ON INTELLIGENT TRANSPORTATION SYSTEMS, VOL.14, NO.3, pp.1162-1175, Sep. 2013
- [3-5] Jun-ichi MEGURO, Yoshiko KOJIMA, Noriyoshi SUZUKI, Eiji TERAMOTO, " Vehicle Trajectory Estimation Technique Using GPS Doppler and Inertial Sensors " , IPSJ Journal, Vol.53, No.1, Jan. pp.212-222, 2012
- [3-6] Venkata Ramani Shreya Yellapantula, Rakesh N.Rao, Shankar C. Subramanian, "Effect of Vehicle-to-Vehicle Communication Latency on a Collision Avoidance Algorithm for Heavy Road Vehicles", 2018 IEEE IV, China, pp.1334-1339, June 2018
- [3-7] 700MHz BAND INTELLIGENT TRANSPORT SYSTEMS, ARIB STANDARD, ARIB STD-T109
- [3-8] Experimental Guideline for Inter-Vehicle Communication Messages, ITS FORUM

RC-013

[3-9] DENSO REPORT, Development of V2V, V2I Communication Technology Toward the Automated Driving Systems, 2017,

<http://www.sip-adus.jp/rd/h27/general.html>

## **Chapter Four: Considerations of Advance Deceleration Using Vehicle to Vehicle Communications**

### **4.1 Background**

Technological development is expected in which automated driving vehicles run on public roads. When an automated driving vehicle travels on general road, unlike Expressways and dedicated roads for automobiles, coexistence or coordination with a priority vehicle (such as an emergency vehicle) must be considered. And also, safety and less stress must be achieved for passengers of automated driving vehicles. Relating to this theme, the studies of vehicle to vehicle communications have been conducted [4-1]. In previous researches, the superiority of vehicle to vehicle communications is examined from the viewpoint of emergency vehicles. For example, shortening the travel time of the emergency vehicle thanks for the evacuating operation of surrounding vehicles by the early recognizing the emergency vehicle approach. However, the problems occurred on the surrounding vehicles are not examined. It is necessary that the stress of passenger should be reduced when automated driving vehicle becomes widespread in the future. This paper investigates any problem whether pre-deceleration is effective for safety and ride comfort.

### **4.2 Superiority of Vehicle to Vehicle Communication in Emergency Vehicle Recognition**

The authors compared siren, red light, and vehicle to vehicle communication with regards to the distance at which the surrounding vehicles can recognize the approach of an emergency vehicle such as an ambulance.

The vehicle to vehicle communication uses a radio system (ARIB STD T-109) [4-2] that has been put to practical use in Japan in 760 MHz band.

The distance of ambulance recognition is siren sound (average 228 m), red light (average 217 m), vehicle to vehicle communication (average 526 m) in LOS (Line Of Sight), siren sound (average 168 m), red light (average 36 m) and vehicle to vehicle communication (average 278 m) is reported in NLOS (Non Line Of Sight) [4-3]. Table 4-1. shows the recognized distance in the real situation.

Table 4-1 The recognized distance in the real situation

		red light	siren sound	V2V
LOS	Max.	374m	380m	570m
	Min.	137m	107m	414m
	Ave.	217m	228m	526m
NLOS	Max.	49m	233m	302m
	Min.	29m	70m	196m
	Ave.	36m	168m	278m

Recognition of red light is the case where it can be recognized in spite of being many obstacles that obstruct the view. As for siren sound, the recognition depends on the quietness in the vehicle interior or driver's music listening. As for the communicable distance of vehicle to vehicle communication, Automobile Bureau of MLIT (Ministry of Land, Infrastructure, Transport and Tourism) compiled the guidelines of the communication operation type driving support system in 2011 [4-1]. It stated that the information is started providing when the linear distance with the emergency vehicle becomes within 300 m. In the real environment, the recognizable distance fluctuates depending on the environmental condition (e.g. radio wave shielding building). When siren sound, red light, and vehicle to vehicle communication are compared at the recognition distance reported in

the literature [4-3], the vehicle to vehicle communication has an advantage in early recognition. It is confirmed that the ambulance approach could be recognized by the vehicle to vehicle communication before the time when the siren sound is heard even in NLOS environment.

In this way, vehicle to vehicle communication is shown to be superior to emergency vehicle recognition (herein, emergency vehicle is referred to as ambulance in this paper), but it is unknown about how the driver takes advantage of the merit and uses it. It is not able to be grasped without observation.

However, the chance of actually encountering an ambulance on public roads is extremely rare and it is not practical to conduct measurement experiments in a real environment.

Therefore, authors decide to collect data by experiments using a driving simulator with specific scenarios.

### **4.3 Experiments by Driving Simulator**

#### 4.3.1 Driving simulator system

The driving simulator used is manufactured by Forum Eight Co., Ltd. The vehicle body is equipped with a 6-axis motion platform, and the seat moves in conjunction with accelerator, brake and steering operations. The screen has a 26-inch LCD monitor on the left, right and front. 7-inch display device with navigation and ambulance approach notification function is on the left side of the driver's seat.

As far as the construction of the virtual road environment, the virtual reality creation software "UC-win / Road Ver. 10 Driving Sim" for the driving simulator of FORUM8 is applied. In UC-win / Road Ver. 10 Driving Sim, the roadways, sidewalks, roadside buildings, roadside trees, traffic lights, etc. are placed in a virtual space to represent an environment close to the actual road environment. The ambulance approaching from backward is recognized by confirming



the image on the rear mirror. Ambulance travel is also realized with this function.

Figure 4-1 shows the appearance of the driving simulator, and Figure 4-2 shows the system configuration of the driving simulator.



Fig. 4-1 Appearance of the driving simulator

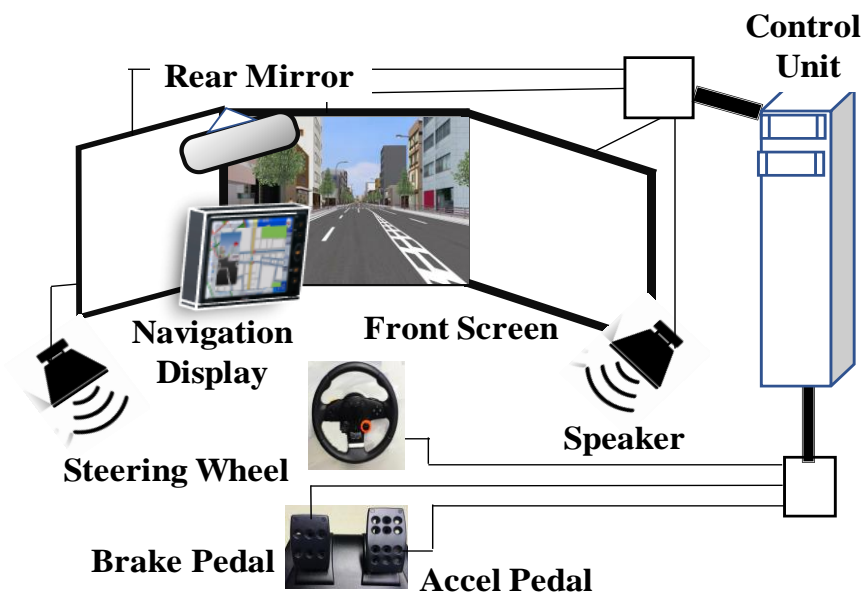

Fig. 4-2 Driving simulator system configuration

Figure 4-3 shows the front screen and the navigation display screen of the driving simulator. An image of ambulance approaching is displayed on the navigation display screen.



Fig. 4-3 Forward screen and car-navigation display

#### 4.3.2 Subjects

When conducting an experiment using a driving simulator for understanding the characteristics of a human driver, it is suitable for the subject to drive daily.

Authors also think of eliminating factors that bias the experimental results. Candidates of the subjects are 75 candidates selected from the generally recruited candidates by screening survey. The condition of the screening is "I have a driver's license and drive one or more times a week". As a result, the frequency of driving is 50%, 32%, and 17% for those who operate 1 to 2 times, 3 to 5 times, and 6 times or more a week. The distribution of gender and age of the subjects is almost the same as 49% women and 51% men. The age distribution is almost equally distributed to 30s 33 %, 40s 33 % and 50s 34 %.

The experiment was conducted in Tokyo from December 1 to 24, 2015 after necessary

procedures based on respect for human rights.

#### 4.3.3 Experimental process

The driving scene of the subject in the driving simulator is taken with a video camera from two places in front of and behind the driver's seat, and the video is recorded. An interview survey is conducted after the experiment of the driving simulator. The recorded video is used to confirm the time of triggers related to recognition and evasion when the ambulance approaches. With regards to recognized time and avoidance start time, accurate identification in interviews is difficult, and for reference, the accelerator and brake signals are actually extracted from the log data of the experiment to estimate the time. The experimental scenario is set as follows. The siren sound is pronounced when approaching to a distance of 60 m.

According to the report by Baba et al. [4-4], about half of drivers notice the sound in the distance to the ambulance being about 60 m, and so the threshold is set to a value of 60 m in the experiment. It is set so that the volume of the sirens would increase every 20 m. The red light is displayed on the rear mirror when there is nothing to obstruct the view when the ambulance approaches from behind. As for vehicle to vehicle communication, the notification of the approach of the ambulance is displayed on the navigation screen with a warning sound of "Pon".

When notifying by vehicle to vehicle communication, the time to notify is when the distance from the ambulance becomes within about 300 m in the case of backward approach. 100 m from the intersection where the ambulance encounters is in the case of lateral direction approach. It is taken into consideration of the attenuation due to radio wave shielding of the surrounding environment. Also, when the ambulance approaches the target

vehicle (subject driving vehicle) up to 100 m, the characters "100 m approach" appears on the navigation display.

The scenario is configured by mixing cases with and without vehicle to vehicle communication for comparison. In addition, 7 scenarios without encountering the ambulance are prepared as a dummy, because the subject would pose if he informed that the ambulance approached in advance. One subject is given a trial run for a total of 10 scenarios with 3 scenarios including an ambulance approach scenario. Figure 4-4. shows an example of scenario setting per subject.

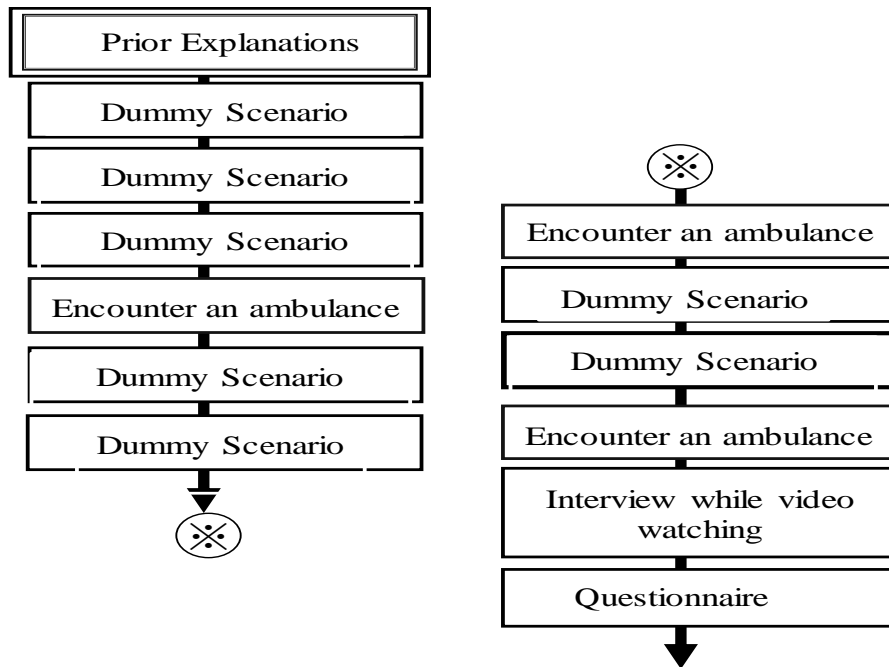

Fig. 4-4 Scenario configuration of a subject

#### 4.3.4 Driving Scenario from backward approach

Figure 4-5 shows an experimental scheme in which the subject drives the target vehicle and the ambulance approaches from backward. The target vehicle travels a road with one lane on one side, there is an intersection ahead, and the target vehicle moves away from the side of the road and stops to take an evasive action to give way to the emergency vehicle.

The amount of operation of each subject while driving and the status of the vehicle are recorded every 0.1 sec. The recording target is the data indicating the status of the target vehicle, such as the subject's ID, accelerator depression rate, brake depression rate, steering wheel operation angle, vehicle type, position (latitude, longitude, altitude), velocity, etc. There are 81 types of records. The time when the subject started traveling from the position of START is set to 0.0 sec, and the elapsed time is recorded as a time axis in units of 0.1 sec.

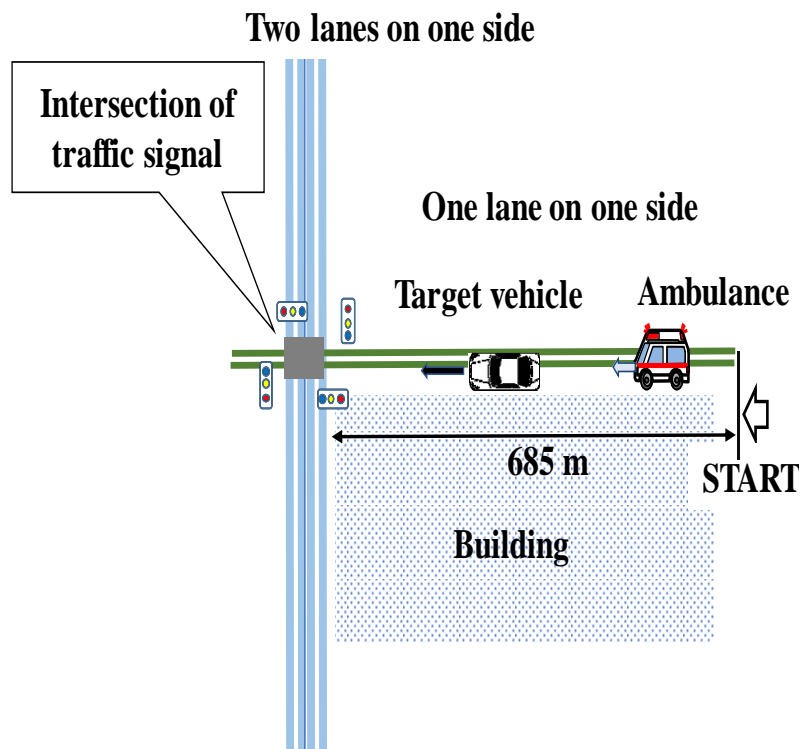

Fig. 4-5 Driving scenario of an ambulance from backward approach

#### 4.3.5 Driving Scenario from lateral direction approach

Figure 4-6 shows an experimental scheme in which the subject drives the target vehicle and the ambulance approaches from lateral direction. The target vehicle travels a road with two lanes on one side, and there is an intersection ahead. In the surrounding area, radio

environments and outlook are bad. Even if the forward traffic signal is "green", the target vehicle decelerates and stops and takes evasive action to give way to the ambulance. The time is the same as in the backward approach, and the time when the subject started traveling from the START position is 0.0 sec, and the elapsed time is recorded as a time axis in units of 0.1 sec. Moreover, the recording object is the same as in the case of the backward approaching.

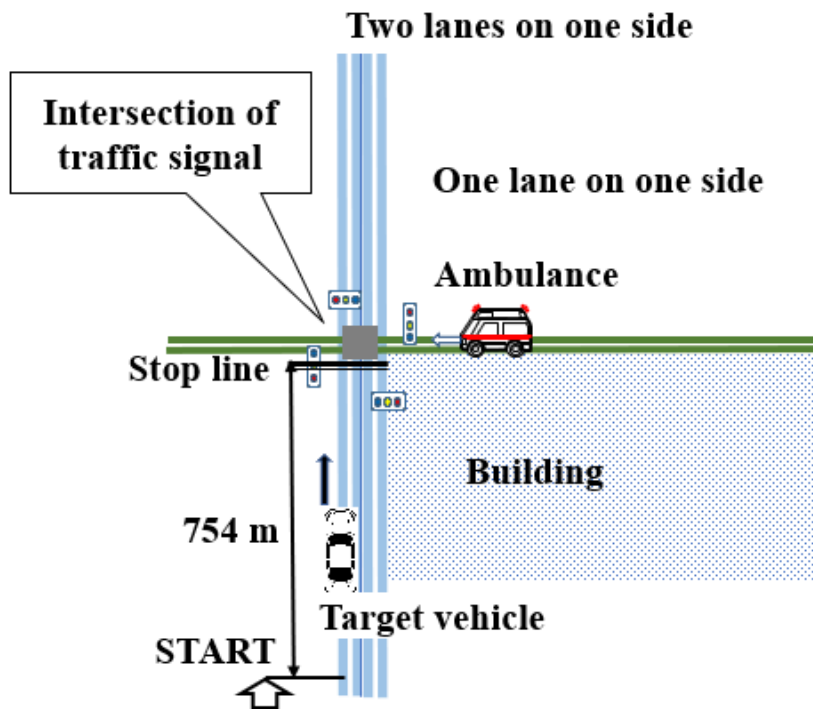

Fig. 4-6 Driving scenario of an ambulance from lateral direction approach

## 4.4 Experimental Data Using Non-V2V Recognition

### 4.4.1 The case of the siren sound recognition from backward approach

There are ten subjects who experimented with a scenario of recognizing with a siren sound when an ambulance approached from backward. Table 4-2 shows experimental data of five persons excluding extreme driving operation data (for example, without stopping and

applying an emergency brake) according to the individuality of the subject. Figure 4-7. shows the experimental data No.63\_7\_1B, which has the shortest time to stop among the subjects. Figure 4-7. shows the data of the brake depression amount, velocity, deceleration and jerk. At the time of recognition, the distance between the target vehicle and the ambulance is 57.9 m, and the velocity of the target vehicle is approximately 32.2 km/h. Awareness is defined as the time when a subject recognizes an ambulance approach.

In this case, the subject recognizes the ambulance's approach with a siren sound at 58.8 sec. After recognition, he starts applying the brake and stops at 64.1 sec and gives way to the ambulance.

Table 4-2  
The data of five subjects notifying an ambulance from backward by siren sound

	Data No.	Velocity at recognition [km/h]	Distance at recognition [m]	Time before stop [sec]	Maximum deceleration [m/s <sup>2</sup> ]	Maximum jerk [m/s <sup>3</sup> ]
Backward Approach / Siren Sound Awareness	63_7_1B	32.2	57.9	5.3	-4.24	-0.73
	40_4_1B	28.7	59.1	16.5	-2.44	-0.62
	54_4_1B	29.1	53.5	6.8	-2.29	-0.61
	45_10_1E	32.7	55.1	8.1	-2.26	-0.6
	67_7_1E	29	56.7	8.4	-2.81	-0.57
	Average	30.34	56.46	9.02	-2.808	-0.626

A maximum deceleration of  $-4.24 \text{ m/s}^2$  and a jerk of  $-0.73 \text{ m/s}^3$  have occurred until the target vehicle stops. The measured data usually contains complex noise. In this experiment, the deceleration is expressed only by subtracting the vehicle velocity, but the jerk indicates the noise removed by the Butterworth filter. The Butterworth filter used is described in Section 4.5. The average data of five subjects is shown in Table 4-3.

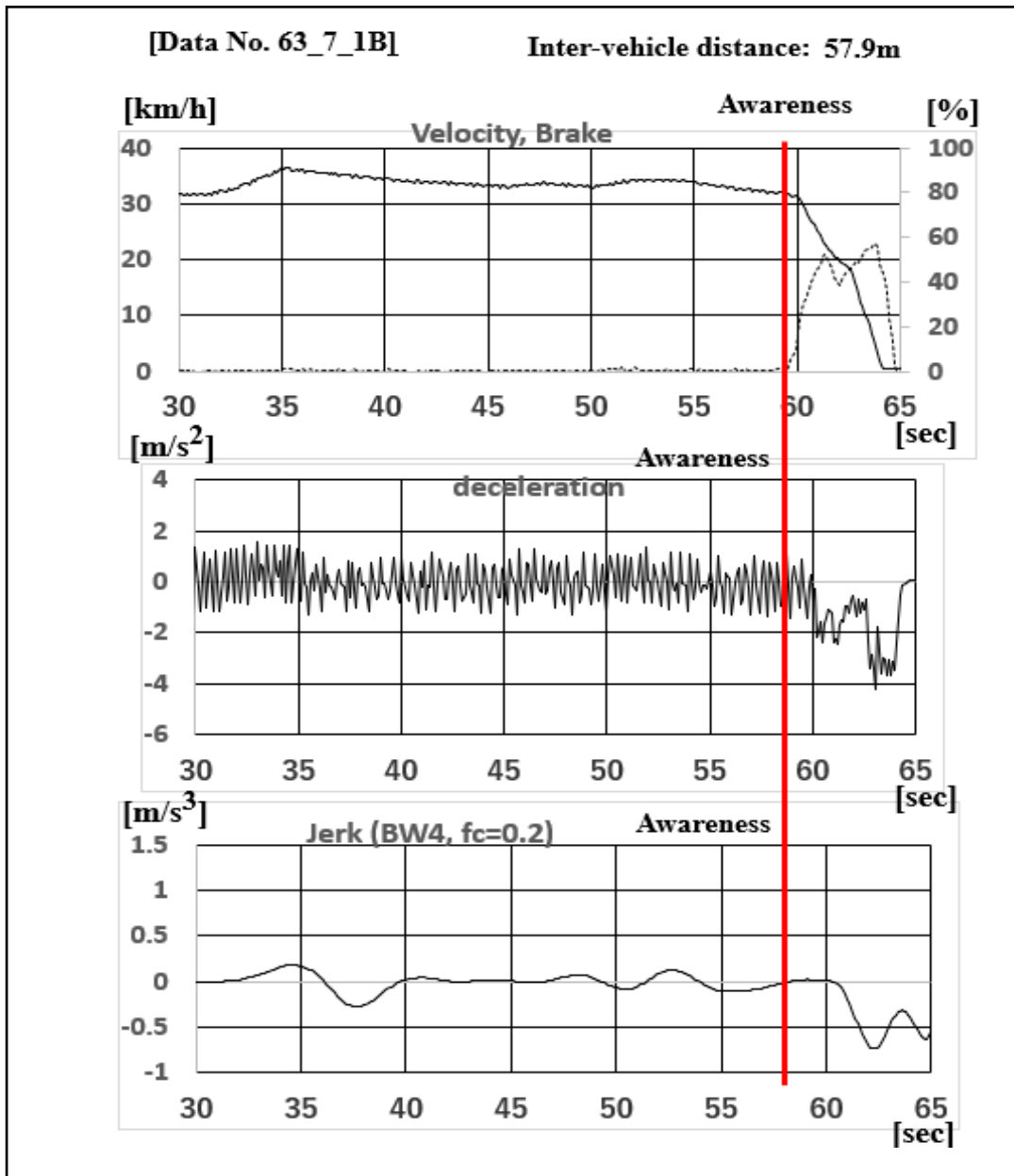

Fig. 4-7 Velocity & Brake, Deceleration and Jerk in Notice by siren sound from backward



#### 4.4.2 The case of the red light recognition from backward approach

There are ten subjects who experimented with a scenario of recognizing with a red light when an ambulance approached from backward. Five subjects excluding extreme driving operation data (for example, without stopping and applying an emergency brake) are considered. The average data of five persons is shown in Table 4-3. Figure 4-8 shows the experimental data No .58\_4\_1E, which is near to the average data. Figure 8 shows the brake depression amount, velocity, deceleration and jerk.

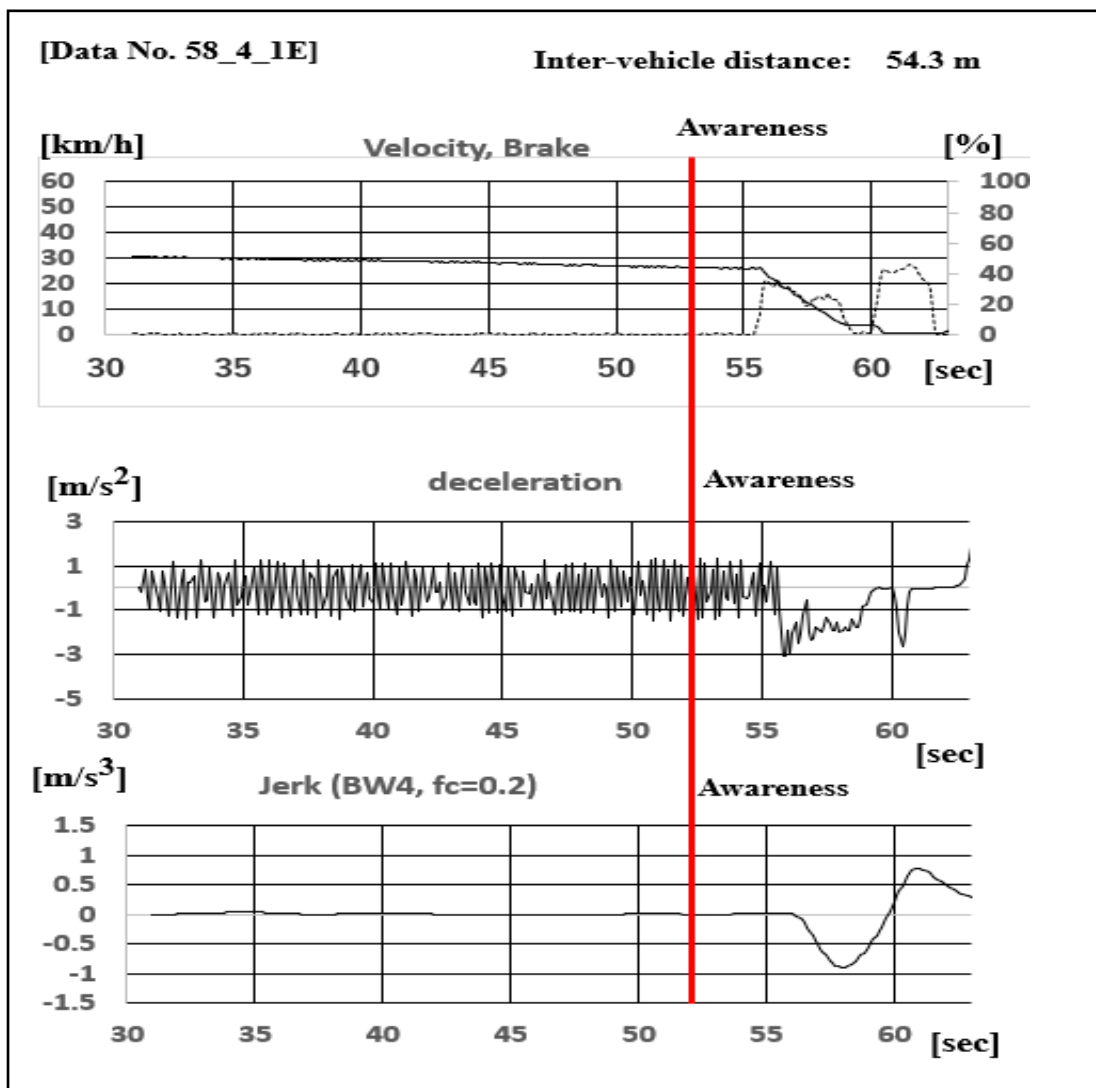

Fig. 4-8 Velocity & Brake, Deceleration and Jerk in Notice by red light from backward

At the time of recognition, the distance between the target vehicle and the ambulance is 54.3 m, and the velocity of the target vehicle is approximately 26.6 km/h. The subject recognizes the approach of the ambulance with the red light reflected on the rearview mirror at 53.3sec. After recognition, he starts applying the brake and stops at 60.6 sec and gives way to the ambulance. A maximum deceleration of  $-3.09 \text{ m/s}^2$  and a jerk of  $-0.895 \text{ m/s}^3$  have occurred until the target vehicle stops.

#### 4.4.3 The case of the siren sound recognition from lateral direction approach

There are ten subjects who experimented with a scenario of recognizing with a siren sound when an ambulance approached from lateral direction. Only two subjects are able to be considered, others are according to the specific individuality of the subject. As for this scenario, the average data of two persons is shown in Table 4-3. Figure 4-9 shows the data of brake depression amount, velocity, deceleration and jerk.

At the time of recognition, the diagonal distance between the target vehicle and the ambulance is 85.7 m, and the velocity of the target vehicle is approximately 50.8 km/h. The subject recognizes the approach of the ambulance with the siren sound at 53.0 sec. After recognition, he starts applying the brake and stops at 59.9 sec and gives way to the ambulance. A maximum deceleration of  $-4.76 \text{ m/s}^2$  and a jerk of  $-1.26 \text{ m/s}^3$  have occurred until the target vehicle stops.

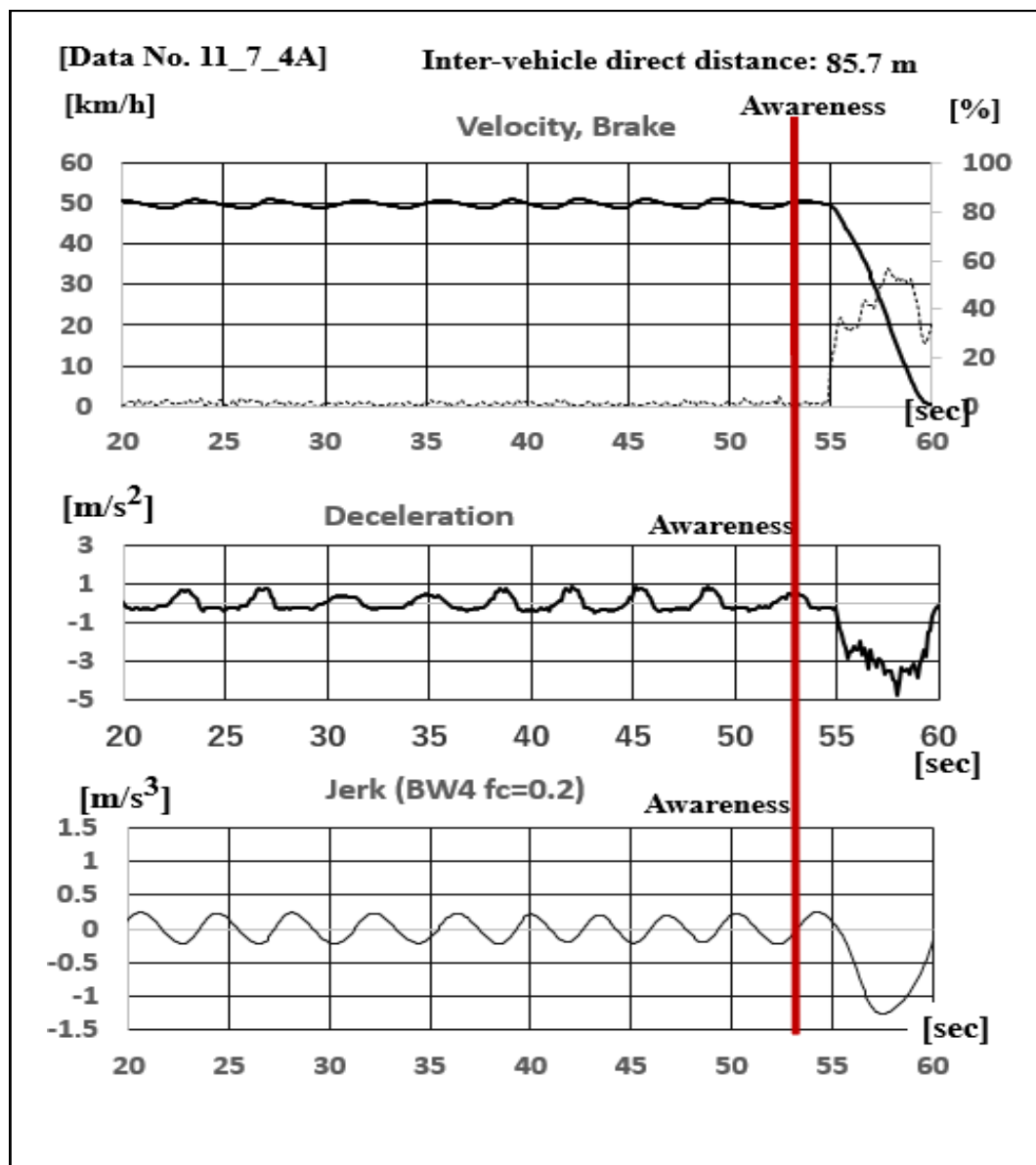

Fig. 4-9 Velocity & Brake, Deceleration and Jerk in Notice by siren sound from lateral direction

#### 4.5 Safety and Ride Comforts

In the previous chapter, while vehicle driven by a human traveling on public roads, when it encounters an ambulance, the time of recognizing an ambulance and driver's action are investigated in the case of siren sound and red light. The average data in case of the

awareness by siren sound and red light are summarized in Table 4-3. The scenario of backward approach and siren sound recognition is the average of five subjects, the average of five subjects as for the backward approach and red light recognition, and the average of two subjects as for the lateral direction and siren sound recognition.

In principle, it should mathematically extract and analyze the deceleration behavior of the subject in each situation for each experimental scenario. The deceleration behavior of a subject varies greatly depending on traffic conditions and emotions, and even if the subject is the same, it is extremely difficult to set up a mathematical model. Therefore, the average data of multiple subjects for each experimental scenario is used. It could be assumed that the referenced data represents the trend of the scheme, not specific data of a specific subject.

**Table 4-3**  
The average data of the subjects notifying an ambulance by siren sound and red light

<b>Direction of Ambulance</b>	<b>Recognized Media</b>	<b>Velocity at recognition [km/h]</b>	<b>Distance at recognition [m]</b>	<b>Time before stop [sec]</b>	<b>Maximum deceleration [m/s<sup>2</sup>]</b>	<b>Maximum jerk [m/s<sup>3</sup>]</b>
<b>Backward</b>	<b>Siren Sound</b>	<b>30.34</b>	<b>56.46</b>	<b>9.02</b>	<b>-2.808</b>	<b>-0.626</b>
<b>Backward</b>	<b>Red light</b>	<b>30.24</b>	<b>53.95</b>	<b>11.74</b>	<b>-3.426</b>	<b>-0.908</b>
<b>Lateral direction</b>	<b>Siren sound</b>	<b>47.35</b>	<b>73.6</b>	<b>6.1</b>	<b>-4.675</b>	<b>-1.47</b>

Next, authors examine whether the results are acceptable for the safety and comfort of the passenger of automated driving vehicles. There are previous studies on car safety and ride comfort [4-5]. Safety and ride comfort have been reported to have a major impact on vehicle acceleration and jerk. Especially, dis-comfort is affected by jerk more than the magnitude of the deceleration itself [4-6].

The safety standards relating to the deceleration and jerk values of automated driving vehicles have not been decided yet. Regarding the current acceleration and deceleration, there is a standard of acceleration determined under the test conditions of the seat belt [4-7], [4-8], that is  $-2.94 \text{ m/s}^2$ . Furthermore, the deceleration in sudden braking seems to be instructed to be  $-0.3 \text{ g}$  or less at driving schools in Japan. As for jerks, research has been actively conducted on railways. For railway vehicle, the steady-state acceleration in the left-right direction is  $0.8 \text{ m/s}^2$  or less for the ride when passing a curve. Based on this indication, jerk of  $-0.784 \text{ m/s}^3$  for safety brakes and jerk of  $-1.25 \text{ m/s}^3$  for emergency brakes are used as important reference values.

The previous study states that the driving style recognized as comfortable for autonomous driving is low jerk and that early action brings out a sense of safety. In our experiments, when there is little time to spare, there is a case where the sense of safety is lost by a short-term action. It is same as the referenced research [4-6]. However, as for the conclusion that the preferred driving style of automatic driving does not always match the driving method of human drivers, it is necessary to be more studied about the relationship between the driving manner of an expert driver and the preferred automated driving style because of the fact an expert driver not giving stress to passengers. The reference [4-9] assumes that non-emergency accelerations that can be accepted in public transport are in the range  $1.08 \text{ m/s}^2$  to  $1.47 \text{ m/s}^2$ . These figures are reference examples in public transport and are assumed to be milder than of automobiles. Considering future safety standard, the ride comfort of the automated driving car should be set to be more suitable value. In this paper, authors define  $-2.94 \text{ m/s}^2$  as the maximum allowable deceleration of a reference value for deceleration and define  $-0.784 \text{ m/s}^3$  as the maximum allowable jerk of a reference value for jerk when discussing the safety of automated driving vehicles.

The data measured in the experiment is usually mixed with various noises, so simply differentiating the deceleration numerically will amplify the noise instead. Therefore, the difference in deceleration is smoothed by the digital filter with a filtering characteristic that is less susceptible to noise and the like. The digital filter used is the Butterworth filter. The coefficients are derived by substituting the parameter of the fourth-order cutoff frequency of 0.2 Hz into the MATLAB “butter” function. Equation (4-1) shows the transfer function of Butterworth filter.

$$H(z) = \frac{B(z)}{A(z)} = \frac{b(1)+b(2)Z^{-1}+b(3)Z^{-2}+b(4)Z^{-3}+b(5)Z^{-4}}{a(1)+a(2)Z^{-1}+a(3)Z^{-2}+a(4)Z^{-3}+a(5)Z^{-4}} \quad (4-1)$$

The coefficients are as follows,

$$b = 1.0e^{-4} * [0.1329, 0.5317, 0.7976, 0.5317, 0.1329]$$

$$a = [1.0, -3.6717, 5.0680, -3.1160, 0.7199]$$

When using the maximum allowable deceleration and the maximum allowable jerk defined in this chapter as the evaluation criteria, the experimental data shown in the previous chapter (recognition by siren sound, red light) are barely met in the case of backward and siren sound notification, but other cases are unacceptable.

In addition, even in the case of the backward and siren sound notification, if the time to stop is small, the maximum deceleration exceeds the allowable ground. In summary, the recognized timing being late and the distance and time to stop being small seem to cause a rapid deceleration. Considering how to drive an automated driving vehicle, authors think it is necessary to have an earlier recognition. Section 4.2 describes that vehicle to vehicle communication is advantageous for early recognition. It is effective to recognize early and

decelerate in advance when considering the ride comfort of the passengers. In an experiment using a driving simulator, authors closely examine the case where the approach of the ambulance is recognized early by vehicle to vehicle communication and the deceleration is started immediately. The next chapter shows the examples of early recognition of an ambulance by vehicle to vehicle communication and pre-deceleration.

## **4.6 Experimental Data Using V2V Recognition**

### **4.6.1 The case of V2V recognition from backward approach with pre-deceleration**

There are five subjects who experimented with a scenario of recognizing with V2V communication when an ambulance approached from backward. Only one subject is able to be considered. Others are excluded from the referencing data in this chapter because they are extreme driving behavior such as continuing to run without stopping, or suddenly stopping with emergency brake. Subjects ignore the V2V information or do not notice it. Figure 4-10. shows the experimental data when a subject recognizes the ambulance approach by vehicle to vehicle communication from backward. The showing data are the brake depression amount, velocity, deceleration and jerk. At the time of recognition, the distance between the target vehicle and the ambulance is 167.4 m, and the velocity of the target vehicle is approximately 28.1 km/h. The subject recognizes the approach of the ambulance by vehicle to vehicle communication at 39.9 sec. After recognition, he starts applying the brake and stops at 52.2 sec and gives way to the ambulance. A maximum deceleration of  $-1.94 \text{ m/s}^2$  and a jerk of  $-0.41 \text{ m/s}^3$  have occurred until the target vehicle stops.

After recognizing the approach of the ambulance, the subject slowly slows down and decelerates in advance. It becomes clear from the interview that siren sound is recognized

at 56.4 sec.

Thanks to vehicle to vehicle communication, this is the case which recognizes the approach of the ambulance about 16.5 seconds earlier than the siren sound.

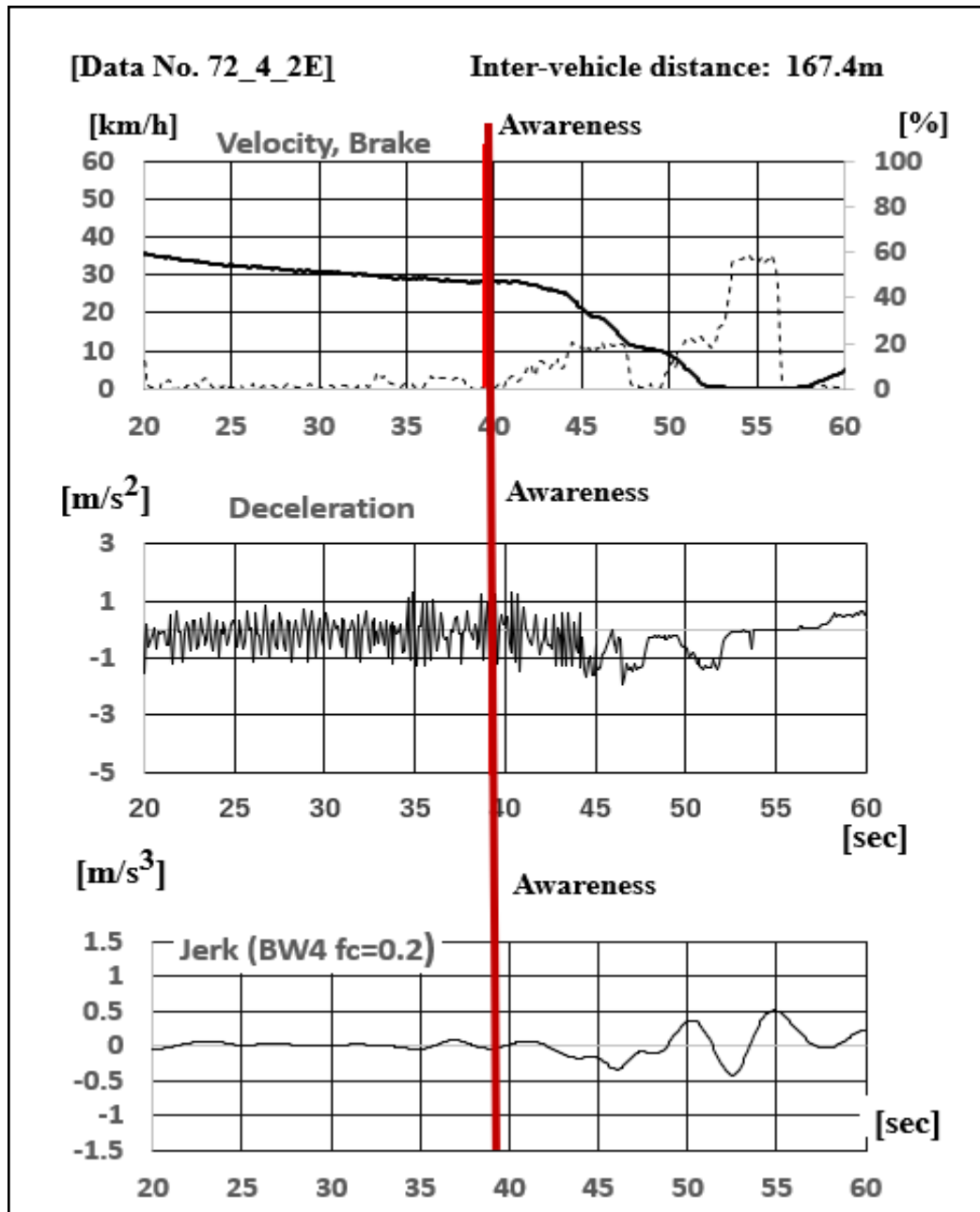

Fig. 4-10 Velocity & Brake, Deceleration and Jerk in Notice by V2V from backward



#### 4.6.2 The case of V2V recognition from lateral direction approach with short pre-deceleration

Figure 4-11 shows the experimental data when a subject recognizes the ambulance approach by vehicle to vehicle communication from lateral direction. The showing data are the brake depression amount, velocity, deceleration and jerk. At the time of recognition, the diagonal distance between the target vehicle and the ambulance is 121.6 m, and the velocity of the target vehicle is approximately 42.5 km/h. The subject recognizes the approach of the ambulance by vehicle to vehicle communication at 50 sec. After recognition, he starts applying the brake and gives way to the ambulance at 53 sec. A maximum deceleration of  $-3.77 \text{ m/s}^2$  and a jerk of  $-0.67 \text{ m/s}^3$  have occurred until the target vehicle stops. After recognizing the approach of the ambulance, the subject slowly slows down in the constant power and decelerates in advance. It becomes clear from the interview that the time of recognition is 5.0 sec earlier than the siren sound.

It can be seen that both the deceleration and the jerk are smaller compared to the case where the recognition is achieved by siren sound and red light described in the previous section.

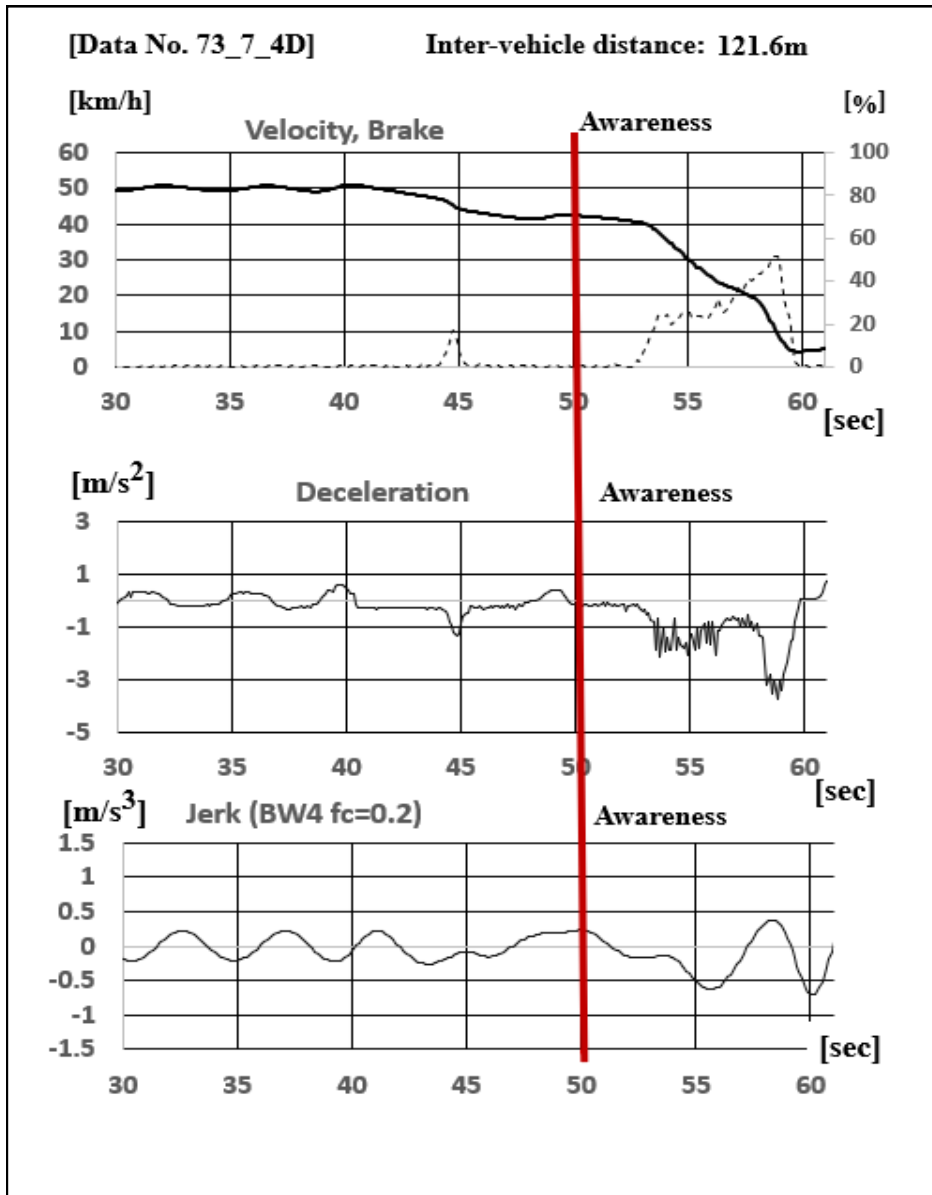

Fig. 4-11 Velocity & Brake, Deceleration and Jerk in Notice by V2V from lateral direction

Table 4-4 The data of the subjects notifying an ambulance by V2V

Direction of Ambulance	Recognized Media	Velocity at recognition [km/h]	Distance at recognition [m]	Time before stop [sec]	Maximum deceleration [m/s <sup>2</sup> ]	Maximum jerk [m/s <sup>3</sup> ]
Backward	V2V	28.1	167.4	12.3	-1.94	-0.41
Lateral direction	V2V	42.5	121.6	9.7	-3.77	-0.67

The experimental data in case of the notice by vehicle to vehicle communication are summarized in Table 4-4. When the maximum allowable deceleration and the maximum allowable jerk defined in this chapter are used as evaluation criteria, the experimental data by vehicle to vehicle communication becomes an acceptable value except for the deceleration of the approach from the lateral direction. Also in the case of approaching from the lateral direction, the maximum deceleration changes from  $-4.675$  to  $-3.77$   $\text{m/s}^2$ , that is about  $0.905$   $\text{m/s}^2$  smaller than in the case of recognition from a siren sound.

By simply comparing the data at the time of awareness by siren sound and red light in Table 4-3. and the data at the time of awareness by vehicle to vehicle communication in Table 4-4., we could not conclude that vehicle to vehicle communication is a necessary and sufficient condition for acceptable ride comfort. This is because the vehicle slows down slowly in this situation, and comfort can be achieved by slowing down slowly. In order to slow down slowly, other situations other than vehicle-to-vehicle communication can be considered (for example, whether there is road information, etc.). However, Tables 4-3. and 4-4. show that there is a significant difference in the direct distance to the ambulance at the time of awareness between the vehicle to vehicle communication and other means of recognition. For vehicle to vehicle communication, the distance is over 100 m, and the siren and red light are under 73.6 m. This allows vehicle-to-vehicle communication to give the driver time to spare. In other words, vehicle to vehicle communication becomes a sufficient condition for ride comfort.

## 4.7 Adaptation to Automated Driving Vehicles

On the assumption that an ambulance is encountered on public roads, authors use a driving simulator to check the vehicle's deceleration and jerk before stopping. As a result, in the case of the siren sound and the red light, the deceleration and the jerk are the value above or near to the maximum allowable safety and the maximum allowable jerk defined in this paper.

As the method to recognize an ambulance approach, siren sound and red light are inadequate in the point of the early recognition. Insufficient time results in a sudden slowdown. If the time to decelerate is earlier, there would be time allowance and the deceleration and jerk would be improved. In order to accelerate the time of deceleration, it is necessary to recognize an early ambulance approach, and the use of vehicle to vehicle communication is desirable.

As a result of experiments in human driving, there is a difference in the deceleration and the jerk on the case with and without the vehicle to vehicle communication. The improvement is seen when the vehicle to vehicle communication is used.

However, it has also been found that the characteristics of the deceleration and the jerk are different depending on the time of starting the pre-deceleration.

Considering adaptation to automated driving vehicle, passenger's safety and ride comfort must be satisfied. The time of starting the pre-deceleration is extremely important and further consideration is needed.

## **4.8 Summary and Future Work**

In the absence of guidelines for safety and ride comfort of automated driving vehicles, the authors confirmed the effectiveness of pre-deceleration using vehicle to vehicle communication on assuming maximum allowable deceleration and maximum allowable jerk.

On the other hand, vehicle to vehicle communication provides greater recognition distance to emergency vehicles than siren sound and red light. Therefore, there is also a possibility that too early pre-deceleration occurs. Too early pre-deceleration has a risk of adversely affecting nearby vehicles. In the future, we would like to study the time to start the optimal pre-deceleration and create guidelines and standards relating to the safety and ride comfort of automated driving vehicles.

## References

- [4-1] ASV: Inter-Vehicle Communication (IVC) based Driving Support System  
<https://www.mlit.go.jp/jidosha/anzen/01asv/resource/data/asv3gizyutusetumei.pdf>
- [4-2].700MHz BAND INTELLIGENT TRANSPORT SYSTEMS, ARIB STANDARD, ARIB  
STD-T109 [http://www.arib.or.jp/english/html/overview/doc/5-STD-T109v1\\_0-E1.pdf](http://www.arib.or.jp/english/html/overview/doc/5-STD-T109v1_0-E1.pdf)
- [4-3] Hideaki NANBA, Yukihiro IKAMI, Kenichiro IMAI, Kenji KOBAYASHI, Manabu SAWADA,  
“An Advantage of the Vehicle to Vehicle Communication for an Automated Driving Car  
at the Encounter with an Ambulance”, IEICE, Vol.E101-A, No.9, pp.1281-1289, Sep.  
2018
- [4-4]. Hirohiko Baba, Masanao Ebata, “Study on detection of the electronic siren from an  
ambulance”, The Journal of the Acoustical of America 100, 2819 (1996)  
<https://asa.scitation.org/doi/abs/10.1121/1.41617>
- [4-5] Hanna Bellem, Barbara Thiel, Michael Schrauf. Josef F. Krems, "Comfort in automated  
driving: An analysis of preferences for different automated driving styles and their  
dependence on personality traits", Transportation Research Part F: Traffic Psychology  
and Behavior, vol.55, pp.90-100, May 2018
- [4-6]. Hanna Bellem, “Comfort in Automated Driving: Analysis of Driving Style Preference in  
Automated Driving”, Doctor Dissertation, Technische Universitat Chemnitz, Germany,  
2018  
<http://monarch.qucosa.de/api/qucosa%3A21407/attachment/ATT-0/>
- [4-7]. Japanese Industrial Standards (JIS) D4604, 95th Edition, January 20, 2006,  
“AUTOMOTIVE PARTS – SEAT BELTS”, Japanese Standards Association (JSA)
- [4-8]. Mohamed Elbanhawi, Milan Simic, Reza Jazar, "In the Passenger Seat: Investigating  
Ride Comfort Measures in Autonomous Cars," IEEE Intelligent Transportation Systems

Magazine, vol.7, no.4, 2015

[4-9]. L.L. Hoberock, "A Survey of Longitudinal Acceleration Comfort Studies in Ground Transportation Vehicles", J. Dyn. Sys., Meas., Control 99(2), pp.76-84, Jun 1977  
<https://repositories.lib.utexas.edu/handle/2152/20856>

[4-10]. Hideaki NANBA, "Next-generation ITS to Support Information Communication", New Breeze Vol.27 No.3 Summer, July 2015  
[https://www.ituaj.jp/wp-content/uploads/2015/07/nb27-3\\_web.pdf](https://www.ituaj.jp/wp-content/uploads/2015/07/nb27-3_web.pdf)

## Chapter Five: Application of Deceleration Stop Model to Pre-Deceleration

### 5.1 Background

There is a discussion about whether the driving style of people and automated driving cars should be the same. As described in Chapter 4, the author actually installed a vehicle-to-vehicle communicator device on an ambulance and conducted driving with a manually operated vehicle in order to examine the driving characteristics when encountering an emergency vehicle. The results confirmed that vehicle-to-vehicle communication is more effective for early ambulance recognition than other media [5-1]. However, even if an ambulance is recognized early, evasive action may not be taken immediately. Also, the vehicle suddenly decelerates when an ambulance is recognized in the immediate vicinity with a siren sound or red light. This kind of maneuver causes uncomfortable deceleration.

In the era of automated driving, driving styles that do not cause discomfort to passengers are desired. For this purpose, it is desirable to develop a new deceleration control method. As a previous study on the riding comfort of automated driving vehicles, the doctoral dissertation by Hanna Bellem of CHEMNITZ Institute of Technology is deserving of reference. According to Dr. Hanna Bellem, the comfortable driving style for automated driving vehicle is characterized by low jerking and by eliciting a feeling of safety through early action. Dr. Bellem also states that driver personality is not a major factor.

However, the author believes that ride comfort is a major factor in how the individual feels. Regarding the method of supporting deceleration, the timing of starting deceleration is important, based on the experimental results of Chapter 4. Pre-deceleration at the optimal timing is considered appropriate for the driving style of automated driving systems. There is prior research on the deceleration support method, and the driving behavior of skilled drivers



is analyzed. The studies are the reference [5-2], [5-3], [5-4], [5-5].

However, in previous studies, evaluation was qualitative and sensory. Although it is effective for driving assistance, in the era when automated driving cars become widespread, an automated driving car needs to travel without causing sudden deceleration unpleasant to the passengers, and it seems that quantitative design and evaluation are necessary. Further, it has been pointed out that the earlier deceleration start operations may adversely affect surrounding vehicles. For example, earlier deceleration may cause congestion. Considering this background, the author used vehicle to vehicle communication that enables early recognition and determined the timing to start pre-deceleration using the deceleration stop model.

## **5.2 Derivation of Deceleration Stop Model**

### 5.2.1 Consideration of mathematical model

In order to determine the optimal pre-deceleration start timing, it is necessary to create a model of vehicle deceleration with respect to stopping distance and speed/deceleration.

Assuming an automated driving vehicle, it has a high-definition map, so it is assumed that the target stop distance to the intersection or stop line ahead is already known at the time of starting the evasive maneuver.

In this study, we examined a mathematical model [5-6] representing deceleration of a skilled driver and the Intelligent Driver Model (abbreviated as IDM) [5-9] described in Chapter 2.

### 5.2.2 Deceleration Model of Skilled Drivers

The feature of the deceleration pattern of skilled drivers is said to be that they use two modes skillfully. Those are, the mode that decelerates so that the collision risk index becomes a constant gradient immediately after the start of braking and the mode that maintains deceleration until the speed reaches 0 are used well. [5-6]. The deceleration pattern and relative speed pattern in the constant gradient mode are expressed by equations (5-1) and (5-2) below. The feature of these equations is that the deceleration and the subsequent speed can be calculated only from the velocity at the deceleration start point (Initial Velocity) and the distance to the stop point.

$$a(t) = \left( \frac{3}{x(t)} - \frac{3}{x(0)} \right) v^2(t) \quad (5-1)$$

$$v(t) = v(0) \frac{x^3(t)}{x^3(0)} \exp\left(\frac{3}{x(0)} (-x(t) + x(0))\right) \quad (5-2)$$

$t$  : Elapsed, the deceleration start timing as 0 [s].

$x(0)$ : Distance to the stopping place at  $t = 0$ .

$x(t)$ : Distance to the stop point at  $t$ .

$v(t)$ : Velocity at  $t$ .

$a(t)$ : Deceleration at  $t$ .

Figures 5-1 shows the graph of deceleration with respect to distance and deceleration.

Figures 5-2 shows the graph of deceleration with respect to distance and elapse.

The velocity at the start of deceleration is 50 km/h and the distance to the stop point is

about 34 m.

A skilled driver decelerates so that the gradient deceleration with respect to the distance to the stop point is constant. Therefore, the deceleration with respect to the transition of the distance shows a dual type symmetrical pattern.

On the other hand, the deceleration pattern over time shows a relatively steep rise at the beginning of deceleration, but finally the deceleration converges to 0 with a smooth curve.

When applying this skilled driver's deceleration pattern to the deceleration of an automated driving vehicle, the adjustment term to approach the actual driver's deceleration pattern is not in the formula and seems not to be able to be fine-tuned.

In addition, it seems that there is a problem in deriving the timing to reduce the discomfort of passengers of automated driving vehicles. A large deceleration is performed in a short time at the start of deceleration and the second half is a deceleration intentionally.

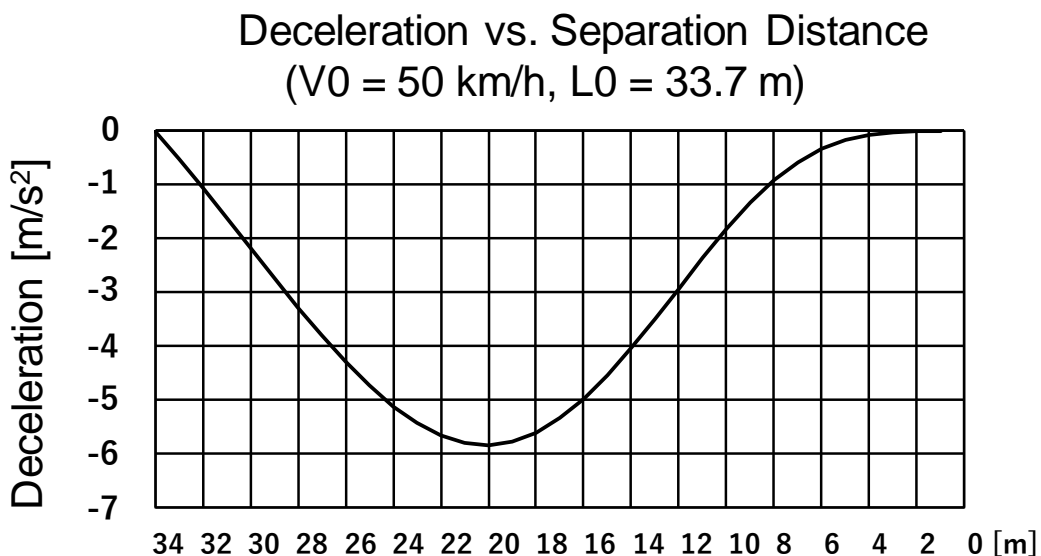

Fig. 5-1 Deceleration vs. Separation distance

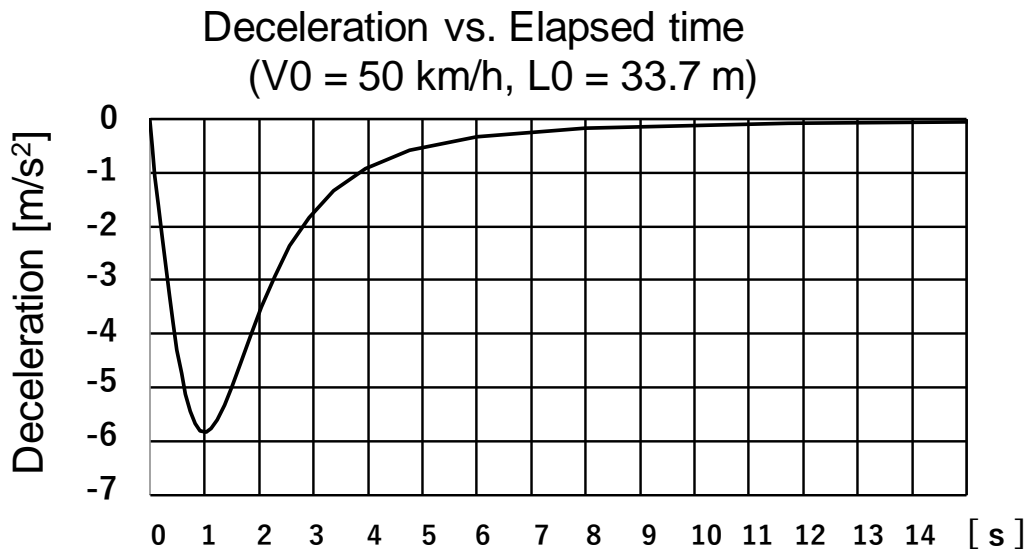

Fig. 5-2 Deceleration vs. Elapsed time

### 5.2.3 Use of IDM (Intelligent Driver Model)

Using the IDM model described in Chapter 2, the timing of the optimal start of deceleration is calculated. The timing should make the automated driving vehicle achieve to stop the desired stop position with desired deceleration and with acceptable jerk.

In Chapter 2, we calculated the distance to stop with inputting the velocity at which deceleration started and the occurring deceleration. In this chapter, it is assumed that the distance to stop is known from a map, etc. The timing to stop over the distance at a predetermined maximum deceleration is derived.

The formula of the IDM model is described again for convenience.

$$\frac{dv}{dt} = -a \left( \frac{s^*(v, \Delta v)}{s} \right)^{2\beta} \quad (5-3)$$

$$s^*(v, \Delta v) = vT + \frac{v^2}{2\sqrt{ab}} \quad (5-4)$$

$$b' = 7500s_j^\gamma \quad (5-5)$$

$$\gamma = -0.0062v_j^2 + 0.2241v_j - 3.7875 \quad (5-6)$$

$$\text{Condition1} \begin{cases} b' \leq 2.1 & \text{then, } b = 2.1 \\ 2.1 < b' \leq 8.0 & \text{then, } b = b' \\ b' > 8.0 & \text{then, doesn't stop} \end{cases} \quad (5-7)$$

Table 5-1 Parameters and Set Values

Parameter	Set Value	Meaning
$a$	2.0 m/s <sup>2</sup>	Maximum acceleration
$b$	Condition 1	Maximum deceleration
$\beta$	4	Exponent Parameter of Deceleration
$v$	- km/h	Current velocity
$v_j$	- km/h	Initial Velocity of Deceleration
$S_j$	- m	Initial Distance to Target Stop Place
$S$	- m	Current Distance to Target Stop Place
$T$	0.2 sec	Headway time

The IDM can adjust the maximum deceleration and the deceleration index, unlike the deceleration behavior model of the skilled driver in the previous section.

The parameters of the mathematical formula were determined with reference to actual data. It was measured from an experiment where an ambulance was approaching from behind when a person actually drove in a DS.

The parameter values used in this study are shown in Table 5-1.

#### 5.2.4 Comparison between the derived deceleration stop model and actual data

Figure 5-3 shows the actual deceleration data when the subject started deceleration at time 57.8 s in the driving simulator (DS) experiment. The simulation result using the deceleration stop model with a velocity (50 km/h) at the start of deceleration and the distance to the stop point (33.7m) is overwritten. The rise, fall, and maximum deceleration show results that are close to the actual data and calculation results.

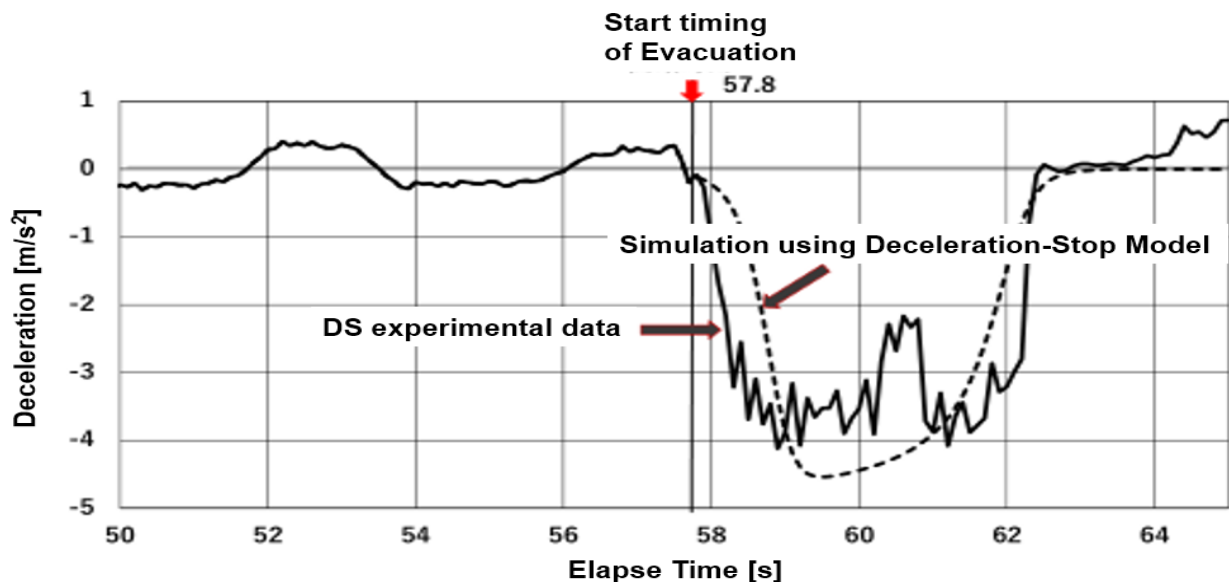

Fig. 5-3 Comparison of DS experimental data and simulation result

The approximation of the model is defined as within approximately  $\pm 8\%$  from the distance to stop and the vehicle length, and the length of the white line on the road. In the case of Figure 5-3, it is about 7%, so we decided to use it as an approximation of the actual data.

Figure 5-4 shows the simulation results using the deceleration stop model for three cases. The first is 52.0 s, when information is provided by vehicle to vehicle communication.

The second is 56.0 s, when a warning message appears. The third is 57.8 s, when deceleration is started in the experiment. The occurring deceleration depends on the timing to start deceleration. If the allowable deceleration is determined in this way, the timing for starting deceleration can be determined.

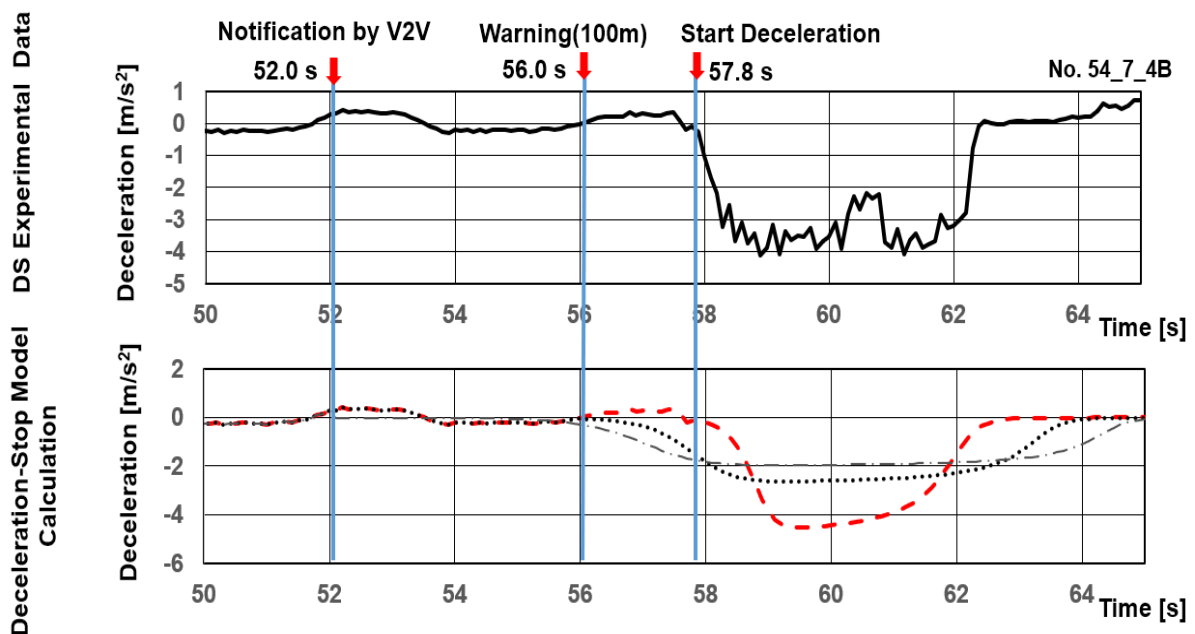

Fig. 5-4 Deceleration simulation using deceleration stop model

### 5.3 Stop Distance Obtained from Deceleration Stop Model

Automobile engineers and skilled drivers have a shared awareness that acceptable deceleration is lower than  $-0.3\text{ g}$  [5-7] in discussions of sudden braking. The definition of sudden braking is not clearly defined, but passengers feel uncomfortable with decelerations over  $-0.3\text{ g}$  [5-8]. The authors considered the maximum allowable deceleration of an automated driving vehicle to be  $-0.3\text{ g}$  ( $-2.94\text{ m/s}^2$ ) and defined it as the maximum deceleration of an automated driving vehicle for the purposes of discussion. The stop distance is defined as the distance to the position at which the velocity fell below 5% of the velocity at the start of deceleration. Using the deceleration stop model described in the previous section, we investigated the time course of deceleration and the stop distance for each velocity when the maximum deceleration is  $-2.94\text{ m/s}^2$ .

Figure 5-5 illustrates the deceleration and stop distance for the initial velocity.

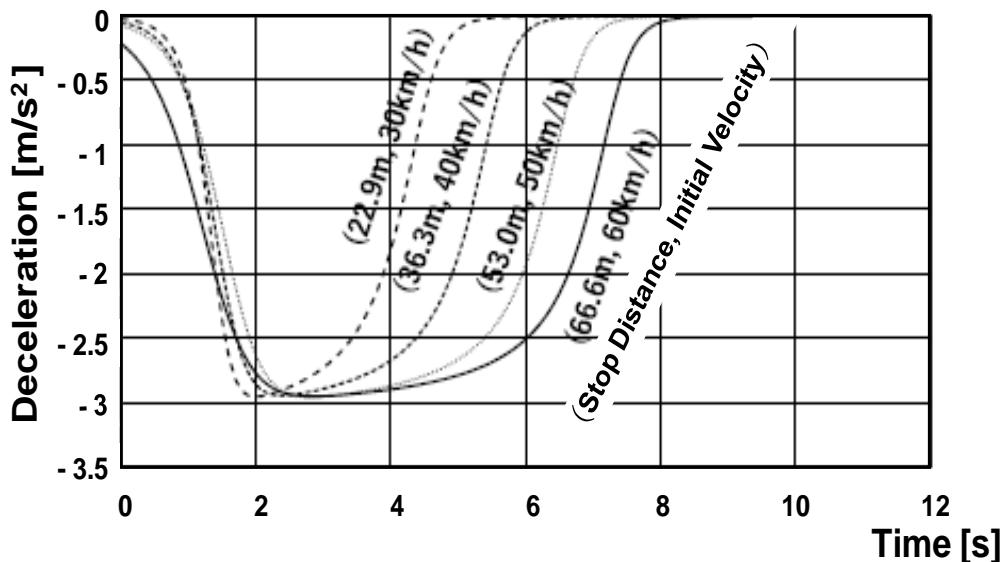

Fig. 5-5 Deceleration and stop distance for initial velocity  
(Maximum deceleration is  $-2.94\text{ m/s}^2$  for every velocity)



The stop distance for each velocity is as follows; 22.9m when the velocity at the start of deceleration is 30km/h, 36.3m when 40km/h, 53.0m when 50km/h, and 66.6m when 60km/h. Figure 5-6 shows the relationship of the velocity ( $v_j$ ) at the time of deceleration start and the distance ( $S_j$ ) to the stop point on maximum deceleration being  $-2.94 \text{ m/s}^2$ . The linear approximation equation is Equation (5-8), and the coefficient of determination  $R^2$  is 0.9981. If a certain point in time  $t$  is the start of deceleration and the velocity at that time is  $v_j(t)$ , the stop distance  $S_j(t)$  is obtained from Equation (5-9), with the condition that the maximum deceleration is  $-2.94 \text{ m/s}^2$ .

$$S_j = 1.478 v_j - 21.81 \text{ [m]} \quad (5-8)$$

$$S_j(t) = 1.478 v_j(t) - 21.81 \text{ [m]} \quad (5-9)$$

If the value  $S_j(t)$  is larger than the distance to the stop point obtained from the map of the automated driving vehicle, the maximum deceleration shall be greater than  $-2.94 \text{ m/s}^2$ .

This means that you cannot stop before the stop point initially planned with stress-less deceleration. Therefore, by calculating this formula continuously, it is possible to obtain the deceleration start timing that makes the maximum deceleration  $-2.94 \text{ m/s}^2$  or less.

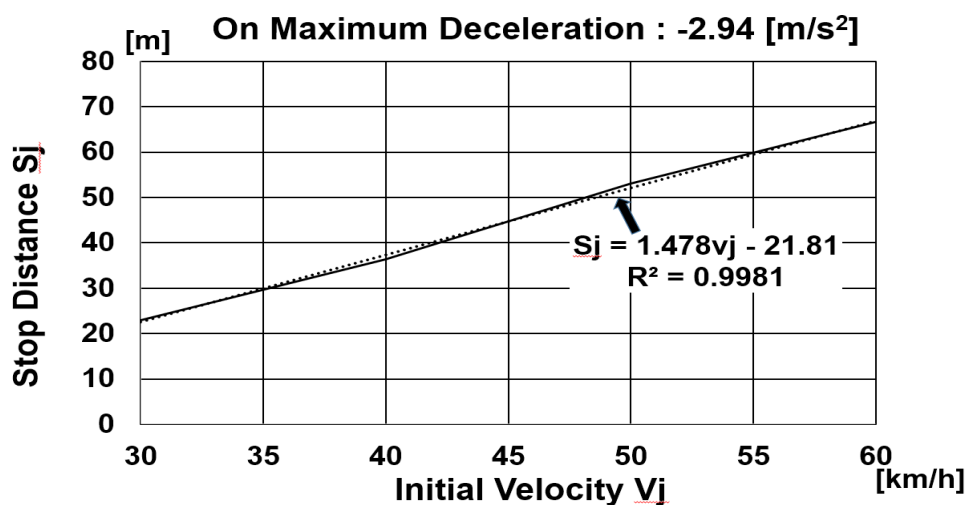

Fig. 5-6 Relationship between initial velocity and distance to stop point

## 5.4 Determining the Start Timing of Deceleration Stop Action

Let's assume a case where an ambulance is approaching from behind and is recognized at an earlier time by vehicle to vehicle communication. If it is recognized that the ambulance is approaching from behind, the automated driving vehicle decelerates and stops. This is the giving way to the ambulance. Figure 5-7 is a flowchart for determining whether a certain time  $t$  is a deceleration start time. The control device for an automated driving vehicle determines whether or not it is a deceleration start time at regular time intervals according to the flowchart. The automated driving vehicle calculates the distance  $D_s$  to the stop point by the mounted map or the map on the net. The stop point is preferably the stop line in front of the intersection. Next, the velocity  $V_j$  at that time is obtained. After that, the safe stop distance  $S_j$  is obtained using the equation (5-9) in the previous section. By comparing  $S_j$  and  $D_s$ , it is determined whether time  $t$  is the deceleration start timing.

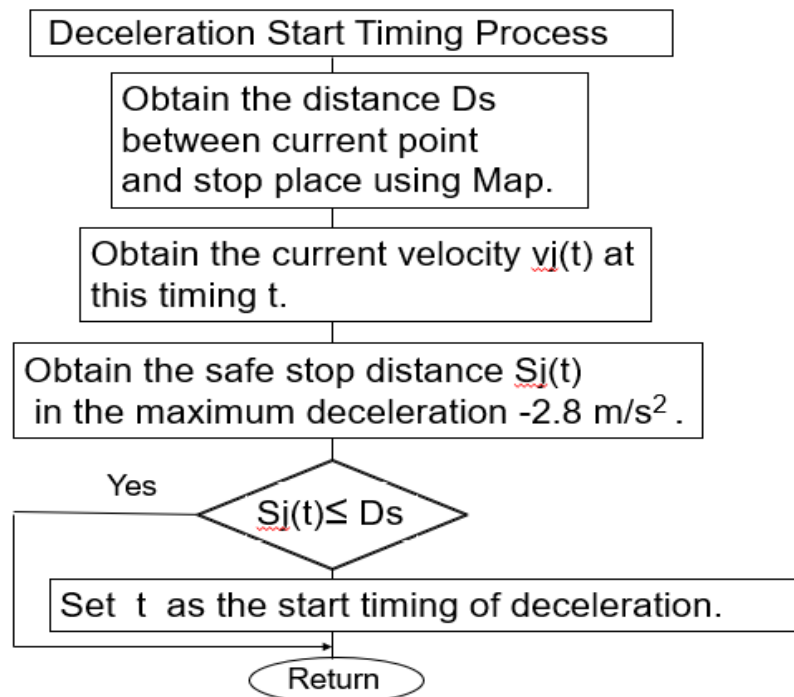

Fig. 5-7 Decision-making flow chart of deceleration start timing

## 5.5 Summary

Vehicle to vehicle communication has a greater recognition distance to emergency vehicles than sirens and red lights. Therefore, there is a possibility of pre-deceleration too early. Too early pre-deceleration can adversely affect nearby vehicles and create traffic congestion. In this paper, we studied a method for obtaining pre-deceleration timing that does not cause sudden deceleration using a deceleration stop model. In the future, I would like to study the timing for starting the optimal pre-deceleration and create guidelines or standards for the safety and ride comfort of automated driving vehicles.

## References

- [5-1] DENSO REPORT, Development of V2V, V2I Communication Technology Toward the Automated Driving Systems. <http://www.sip-adus.jp/rd/h27/general.html>
- [5-2] Takahiro WADA, Syunichi DOI, Naohiko TSURU, Kazumi ISAJI, Hiroshi KANEKO , “Comfortable brake assist system based on analysis of expert driver's behaviors” , DENSO Technical Review, Vol.15, pp.95-101, 2010
- [5-3] 700MHz BAND INTELLIGENT TRANSPORT SYSTEMS, ARIB STANDARD, ARIB STD-T109
- [5-4] Hideaki NANBA, Yukihito IKAMI, Kenichiro IMAI, Kenji KOBAYASHI, Manabu SAWADA, “An Advantage of the Vehicle to Vehicle Communication for an Automated Driving Car at the Encounter with an Ambulance”, IEICE, Vol.E101-A, No.9, Sep. 2018, pp.1281-1289
- [5-5] Hideaki NANBA, Manabu SAWADA, Hiroki KAWANAKA, Koji OGURI, “Yielding Operation in Encounters with Emergency Vehicles and Analysis of Driver’s Operation”, --- The vehicle to vehicle communication and its problem toward automated driving cars ---, IEICE Technical Report WEB2018-60, ITS2018-43, pp.181-186, 2018
- [5-6] Makoto ITO, Yoshitaka MARUMO, Toshihiro HIRAOKA, Takahiro WADA, Genya ABE, Sou KITAJIMA, “Automobile rear-end collision prevention technology for reducing traffic accidents” , CORONA CORPORATION, ISBN978-4-339-04642-7、2015
- [5-7] JIS D4604, “Technical Standard of Seat Belt”, Notice of the Minister of Land, Infrastructure, Transport and Tourism to prescribe the safety standards Article,2003.09.26
- [5-8] Koji OMINO, Hiroaki SHIROTO, Hiroharu ENDOH, “A study of braking patterns in terms of ride comfort”, Japan Ergonomics Society, Vol. 42, No.3, 2006

[5-9] M.Treiber, A.Hennecke, D.Helbing, "Congested traffic states in empirical observations and microscopic simulations", Physical Review E62, No.2, pp.18051824,2000

## Chapter Six: Conclusion

There have been many studies around automated driving systems [6-1] – [6-20]. They seek to develop a safe and effective transportation society. Thinking of the continuity and progress with conventional systems, cooperation with priority vehicles, in particular emergency vehicles, is important.

In this dissertation, the author compared various recognition methods of priority vehicles and showed that there is an advantage to recognition using vehicle to vehicle communication. This is expected to be used for the development of automated driving vehicles that must coexist and operate with priority vehicles in public roads. As for the driving style of automated driving vehicle, the ride comfort of passengers should be examined in the future.

The author initially conducted experiments in actual road environments. Using priority vehicles (ambulances, trams) equipped with wireless communication devices and general cars, the communication performance (communication distance, notification timing, etc.) was investigated. I collected basic data and analyzed basic characteristics for solving the above expectations and problems.

The following summarizes the results obtained in each chapter and shows the direction for future initiatives.

In Chapter 2, I collected and analyzed data indicating how nearby vehicles behave at intersections. In an intersection, traffic environment information can be conveyed to the surroundings via road-to-vehicle communication, and emergency vehicles are equipped with

vehicle-to-vehicle communication devices.

The analyzed data was mathematically processed, and a deceleration stop model was derived. Using this model during encounters with an emergency vehicle, the desired stop distance of a general vehicle is obtained. Furthermore, by comparing the perceived distance measured in the actual environment, when a nearby general vehicle recognizes the approach of a priority vehicle, recognition by vehicle to vehicle communication is superior in terms of the separation distance compared to a siren sound and red lights.

In Chapter 3, I conducted a communication performance experiment using a tramcar in Hiroshima and analyzed data from the viewpoint of issues specific to trams. Automated driving vehicles must coexist with trams as priority vehicles in addition to emergency vehicles. In a previous study, a number of vehicle-to-vehicle communication performance characteristics were investigated targeting general vehicles and put into practical use in 2015. However, the performance evaluation of vehicle to tram communications has not been carried out other than in part. It has been confirmed that a wireless system put into practical use has sufficient communication distance and communication capacity necessary for recognizing the approach of trams.

In Chapter 4, using a driving simulator, we analyzed drivers' maneuvers and vehicle data when encountering an emergency vehicle, using a siren sound, red lights, and vehicle to vehicle communication as the recognition means. Previous studies have reported the merits to emergency vehicles (reduction of arrival time, etc.) due to vehicle to vehicle communication when automated driving vehicles collaborate with priority vehicles.

However, problems that occur with the surrounding vehicles have not been examined, and in particular, it is necessary to examine the safety and ride comfort of passengers of automated driving vehicles. From the research results up to the previous chapter, early recognition of emergency vehicles using vehicle to vehicle communication is considered promising. However, there is a concern about early recognition and premature avoidance actions will cause traffic congestion. From results scrutinizing vehicle velocity, brake operation, deceleration, and jerking, vehicle to vehicle communication can recognized priority vehicles earlier than the recognition by siren sound and red lights. It becomes possible to drive more slowly in advance and avoids excessive deceleration and unpleasant over-deceleration (jerking). This is a suggestion obtained through this research.

In Chapter 5, an algorithm is proposed for applying the deceleration stop model derived in Chapter 2 to determine the timing for starting pre-deceleration. In practice, we find the timing to start deceleration only from the stop distance and velocity that will give the maximum allowable deceleration set in advance.

In the era of automated driving, a driving style that can provide a comfortable ride and does not cause discomfort to passengers is desired, and the development of a new deceleration control method is eagerly desired. Previous studies have explained that a driving style with a small jerk and early action are important for ride quality of automated driving vehicles. Based on the results of Chapter 4, the timing to start deceleration is important in order to satisfy the above items, and it was considered that the desired driving style is to start pre-deceleration at an appropriate time.



In the future, a new driving style for automated drives should be established in terms of passenger comfort and safety, based not only on the conclusions obtained in this paper, but also research on collaborative systems that share information from nearby vehicles and road managers.

## References

- [6-1] Pongsathoru Raksincharoensak, "Motion Planning and control of autonomous Driving Intelligence System Based on Risk Potential Optimization Framework", International Journal of Automotive Engineering, Vol.7, No.1, pp53-60, 2016
- [6-2] Kentaro Takaki, Shigeki Nishimura, Masuda Kenichi, Akira Suwa, Shoichi Tanada, "Evaluation of system providing real time traffic information for automated vehicles based on probe data", ITS AP Forum 2018 Fukuoka, Proceeding, pp.0258-0263, 2018
- [6-3] Erik Ward, John Folkesson, "Towards Risk Minimizing Trajectory Planning in On-Road Scenarios", 2018 IEEE Intelligent Vehicles Symposium (IV), Proceeding, pp.490-497, 2018
- [6-4] Guangming Xiong, Ziyi Kang, Hao Li, Weilong Song, Yaying Jin, and Jianwaei Gong, "Decision - making of Lane Change Behavior Based on RCS for Automated Vehicles in the Real Environment", 2018 IEEE Intelligent Vehicles Symposium (IV), Proceeding, pp.1400-1405, 2018
- [6-5] Venkata Ramani Shreya Yellapantula, Rakesh N. Rao, Shankar C. Subramanian, "Effect of Vehicle -to-Vehicle Communication Latency on a Collision Avoidance Algorithm for Heavy Road Vehicles", 2018 IEEE Intelligent Vehicles Symposium (IV), Proceeding, pp.1334-1339, 2018

- [6-6] Chaitanya Yavvari, Zoran Duric, Duminda Wijesekera, "Cooperative Collision Avoidance by Sharing Vehicular Subsystem Data", 2018 IEEE IV, China, June 26-30, pp.1346-1353, 2018
- [6-7] Omer Sahin Tas, Christoph Stiller, "Limited Visibility and Uncertainty Aware Motion Planning for Automated Driving", 2018 IEEE IV, China, June 26-30, pp.1171-1178, 2018
- [6-8] Chiyu Dong, John M. Dolan, Bakhtiar Litkouhi, "Emergency Autonomous Vehicle Guidance Under Steering Loss", 2018 IEEE IV, China, pp.2078-2083, 2018
- [6-9] Chiyu Dong, John M. Dolan, Bakhtiar Litkouhi, "Smooth Behavioral Estimation For Ramp Merging Control In Autonomous Driving", 2018 IEEE IV, China, pp.1692-1697, 2018
- [6-10] A.V.S.Sai Bhargav Kumar, Adarsh Modh, Mithun Babu, Bharath Gopalakrishnan, K. Madhava Krishna, "A Novel lane Merging Framework with Probabilistic Risk based Lane Selection using Time Scaled Collision Cone", 2018 IEEE IV, China, pp.1406-1411, 2018
- [6-11] Zubair Amjad, Axel Sikora, Benoit Hilt, Jean-Philippe Lauffenburger, "Low Latency V2X Applications and Network Requirements: Performance Evaluation", 2018 IEEE IV, China, pp.220-225, 2018
- [6-12] Ryan Yee, Ellick Chan, Carmine Senatore, Bin Cheng, Gaurav Bansal, "Collaborative Perception for Automated Vehicles Leveraging Vehicle-to-Vehicle Communications", 2018 IEEE IV, China, pp.1099-1106, 2018

- [6-13] Keisuke Yoneda, Naoya Hashimoto, Ryo Yanase, Mohammad Aldibaja, Naoki Suganuma, "Vehicle Localization using 76GHz Omnidirectional Millimeter-Wave Radar for Winter Automated Driving", 2018 IEEE IV, China, pp. 971-977, 2018
- [6-14] Michael R.Hafner, Drew Cunningham, Lorenzo Caminiti, Domitilla Del Vecchio, "Cooperative Collision Avoidance at Intersections: Algorithms and Experiments", IEEE Transaction on Intelligent Transportation Systems, Vol.14, No.3, Sep., 2013
- [6-15] Vicente Milanés, Steven E. Shladover, "Modeling Cooperative and Autonomous Adaptive Cruise Control Dynamic Responses Using Experimental Data", HAL archives-ouvertes, Transportation research. Part C, Emerging technologies, Elsevier,2014. pp.285-300, 2014
- [6-16] Masahi Yamamoto, Tomonori Okugi, Yohei Iwashita, Haruki Okazaki, Haruhisa Kore, Tomonori Hasegawa, "Functionality Tests of Advanced Safety Vehicle Using Vehicle to Tram communication on Hiroshima Public Roads", Mazda Technical Report, No.32, pp. 234 – 239, 2015
- [6-17] Venkata Ramani Yellapantula, Rakesh N. Rao and Shankar C. Subramanian, "Effect of Vehicle-to-Vehicle Communication Latency on a Collision Avoidance Algorithm for Heavy Road Vehicles", 2018 IEEE Intelligent Vehicle Symposium (IV), China, pp.1334-1339, 2018
- [6-18] Md. Abdus Samad Kamal, et.at. "Smart Driving of a Vehicle Using Model Predictive Control for Improving Traffic Flow", IEEE TRANSACTION ITS, VOL.15, NO.2, April, 2014

[6-19] Alexey Vinel, Nikita Lyamin, Pavel Isachenkov, "Modeling of V2V Communications for C-ITS Safety Applications: A CPS Perspective", IEEE COMMUNICATIONS LETTERS, VOL.22, NO.8, August, 2018

[6-20] ERIK STEINMETZ, et.at., "Collision-Aware Communication for Intersection Management of Automated Vehicles", SPECIAL SECTION ON EMERGING TECHNOLOGIES ON VEHICLE TO EVERYTHING(V2X), IEEE Access, VOLUME, 2018

## **Acknowledgements**

I am deeply grateful to my supervisor Professor Koji OGURI at Aichi Prefectural University for affording me the opportunity to complete my dissertation and continued support throughout this study. I have been learning and studying quite fruitful technical subjects in his laboratory. I also thank Professors Yoshimi KAMIYAMA and Takashi OKUDA for their recommendations.

I would also like to thank Dr. Manabu SAWADA, General manager of M-System R&D Dept. Advanced Mobility Systems R&D Division, DENSO CORPORATION for helpful advice and encouragement to continue my study. I would like to thank Mr. Takeo KAWAI, Mr. Yukihiro IKAMI, Mr. Kenichiro IMAI, Mr. Kenji KOBAYASHI for beneficial support and continuous discussions to complete the study.

This study is the result of work supported by a Japanese Government Project SIP, the MIC's ICT for the Next Generation ITS. I wish to thank the Ministry of Internal Affairs and Communications Radio Unit Mobile Communication Division for giving me the opportunity to conduct this study.

I also thank the Nagoya City Fire Department, Aichi Prefectural Department of Industry, and Aichi Prefectural Police for their support.

I would thank Hiroshima Electric Railway, Chuden Engineering Consultants, SANSEI SYSTEM CO., LTD for their support of the field tests.

## List of Publications

### A. Journals

- [A-1] Hideaki NANBA, Manabu SAWADA, Koji OGURI, "Study on Pre-Deceleration Running in Encounters with Emergency Vehicle Using Vehicle to Vehicle Communications", International Journal of Intelligent Transportation Systems Research (IJIT), Dec. 2019, DOI: 10.1007/s13177-019-00212-2
- [A-2] Hideaki NANBA, Yukihito IKAMI, Kenichiro IMAI, Kenji KOBAYASHI, Manabu SAWADA, "An Advantage of the Vehicle to Vehicle Communication for an Automated Driving Car at the Encounter with an Ambulance", IEICE TRANS. FUNDAMENTALS, VOL.E101-A, NO.9, SEPTEMBER, 2018

### B. International Conferences

- [B-1] Hideaki NANBA, Takeo KAWAI, Manabu SAWADA, Md. S. BHUIYAN, Koji OGURI, "Field Operational Test of V2V between Tramcars and Cars Towards Automated Driving System", 2019 IEEE Intelligent Vehicles Symposium (IV), pp.2207-2213, Paris, France, June 9-12, 2019

## C. Domestic Conferences

- [C-1] Hideaki NANBA, Manabu SAWADA, Koji OGURI, “Study on Pre-Deceleration Running in Encounters with Emergency Vehicles Using Vehicle to Vehicle Communications”, The 17<sup>th</sup> ITS Symposium, 2019
- [C-2] Hideaki NANBA, Manabu SAWADA, Koji OGURI, “Application of Evasive Action Model in Encounters with Emergency Vehicle to Pre-Deceleration Running”, THE INSTITUTE OF ELECTRONICS, INFORMATION AND COMMUNICATION ENGINEERS, TECHNICAL REPORT OF IEICE, ITS2019-12, 2019
- [C-3] Hideaki NANBA, Manabu SAWADA, Hiroki KAWANAKA, Koji OGURI, “Yielding Operation in Encounters with Emergency Vehicles and Analysis of Driver’s Operation”, THE INSTITUTE OF ELECTRONICS, INFORMATION AND COMMUNICATION ENGINEERS, TECHNICAL REPORT OF IEICE, ITS2018-43, 2018
- [C-4] Hideaki NANBA, Kenji KOBAYASHI, “The use case of the prioritized vehicle among the connected cars --Expectation of the shortening travel time of ambulance car using V2V communication --”, THE INSTITUTE OF ELECTRONICS, INFORMATION AND COMMUNICATION ENGINEERS, TECHNICAL REPORT OF IEICE, ITS2016-38, 2016
- [C-5] Hideaki NANBA, “V2V, V2I Communication Technology toward the Automated Driving Systems”, Journal of the ITU Association of Japan, July 2015, Vol.45, No.7